

# FG-D-CWP / FG-D-ACWP

(This document is included in the packing contents for the balance.)

Quick Start Guide For Water proof platform scale .....	<b>English (EN)</b>	3
Guide de démarrage rapide Pour balance plate-forme étanche .....	<b>Français (FR)</b>	9
Schnellstartanleitung Für wasserfeste Plattformwaage .....	<b>Deutsch (DE)</b>	15
Guía de inicio rápido Para báscula de plataforma a prueba de agua .....	<b>Español (ES)</b>	21
Guida introduttiva Per bilancia a piattaforma impermeabile .....	<b>Italiano (IT)</b>	27
快速入門指南 防水台秤用 .....	<b>中文 (CT)</b>	33



## Warning Definition

The warning definition described in this manual has the following meaning:

 DANGER	AN imminently hazardous situation which, if not avoided, will result in death or serious injury.
--	--

© 2022 A&D Company, Limited. All rights reserved.

No part of this publication may be reproduced, transmitted, transcribed, or translated into any language in any form by any means without the written permission of A&D Company, Limited.

The contents of this publication and the specifications of the instrument covered by this publication are subject to change for improvement without notice.



# 1. Introduction

This quick start guide describes the basic functions and operations of this product.

The FG-D-CWP / FG-D-ACWP weighing indicator may be used on a waterproof platform scale with IP67 performance. It has similar specifications and functions as an indicator of the FG-CWP series.

Detailed information about FG-D-CWP / FG-D-ACWP is provided in the following instruction manuals.

These manuals can be downloaded from the A&D website (<https://www.aandd.jp>).



Scan this QR code for this manual.

[FG-D-CWP / FG-D-ACWP Instruction Manual]

This is an instruction manual utilized when connecting and installing the FG-D-CWP / FG-D-ACWP to a weighing platform (load cell).







[FG-CWP / FG-ACWP Series Instruction Manual]

This is an instruction manual for understanding and fully utilizing the waterproof digital platform scale FG-CWP series.

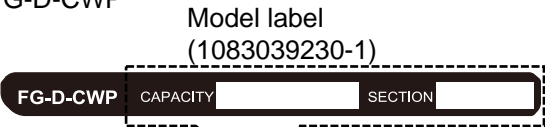
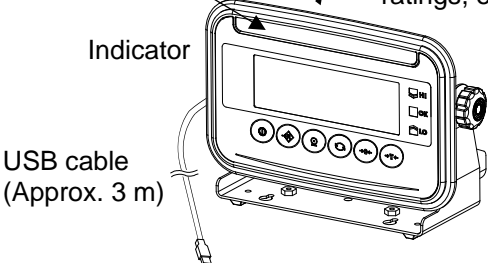

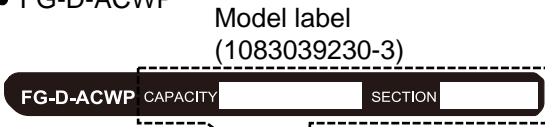
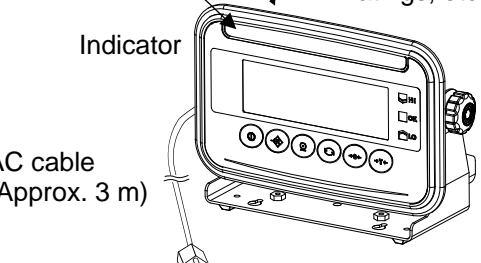
# 2. Items Included

The following items are packed with the product.

FG-D-CWP (USB power model)	FG-D-ACWP (AC power model)
<ul style="list-style-type: none"> <li>• FG-D-CWP                             <div style="text-align: center;">                                 Model label (1083039230-1)                             </div>  <p>Write the scale's ratings, etc.</p>  <p>Indicator USB cable (Approx. 3 m)</p> <ul style="list-style-type: none"> <li>• AC adapter                                      <p>(Image diagram)</p> </li> </ul> </li> </ul>	<ul style="list-style-type: none"> <li>• FG-D-ACWP                             <div style="text-align: center;">                                 Model label (1083039230-3)                             </div>  <p>Write the scale's ratings, etc.</p>  <p>Indicator AC cable (Approx. 3 m)</p> </li> </ul>
<p>※ FG-D-CWP / FG-D-ACWP common accessories</p> <ul style="list-style-type: none"> <li>• Quick start guide                              </li> <li>• Rubber packing (To be used when the diameter of load cell cable is from <math>\phi 3.5</math> to <math>\phi 7.0</math>)                              </li> <li>• Rubber feet for display stand (4 pcs.)                              </li> </ul>	



## 3. Cautions



### 3.1. Precautions for Installing the Indicator



#### **DANGER**

- Ground the scale, so that the user will not be subjected to an electric shock.
- To prevent electric shock, do not handle the USB cable / AC cable with wet hands.
- The USB plug is not water-resistant. Use a USB outlet located at a place where the plug will not get wet. (For FG-D-CWP (USB power model))
- The AC plug is not water-resistant. Use an electrical outlet located at a place where the plug will not get wet. (For FG-D-ACWP (AC power model))
- Do not install the scale where flammable or corrosive gas is present.
- Do not put excessive force on cables.
- The scale is heavy. Use caution, as lifting may cause it to fall over.
- Use shielded load cell cables.

Please read "Precautions for Installing the Scale" in [Instruction Manual: FG-CWP / FG-ACWP Series] on the A&D website (<https://www.aandd.jp>) for other precautions, cautions as an assembled scale, storage and cleaning.

Please read "Installation and Precautions" in [Instruction Manual: FG-D-CWP / FG-D-ACWP] on the A&D website (<https://www.aandd.jp>) regarding connection of load cells, installation of indicators, function setting and sensitivity adjustment, etc.



### 3.2. Load Cell Connection

FG-D-CWP / FG-D-ACWP has two connection configurations: the 6-wire configuration and the 4-wire configuration.

We recommend connecting using the 6-wire configuration for optimum accuracy and stability.

The applicable diameter of load cell cable is from  $\phi 3.5$  to  $\phi 9.0$  mm.

The length of the load cell cable should be less than 30m. For 4-wire configuration, we recommend using a length of 5m or less.

Terminal No.	Function	
1	SIG-	Load cell input (-)
2	SIG+	Load cell input (+)
3	EXC-	Load cell excitation voltage (-)
4	SEN-	Sensing input (-)
5	SEN+	Sensing input (+)
6	EXC+	Load cell excitation voltage (+)
7	SHIELD	Shield

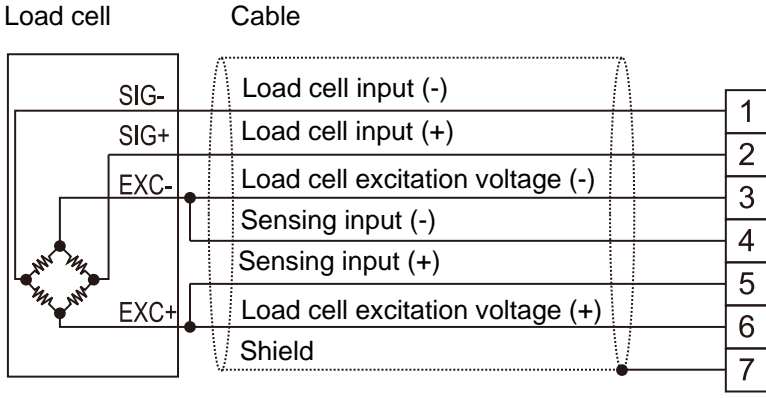

(A) 6-wire configuration connection to load cell (recommended)

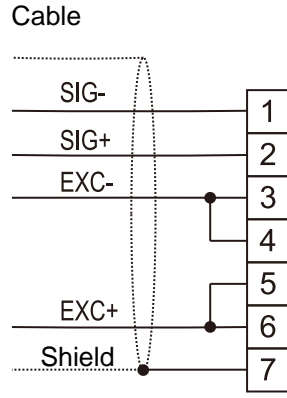

(B) 4-wire configuration connection to load cell



# 4. Part Names

## <FG-D-CWP (USB power model)>

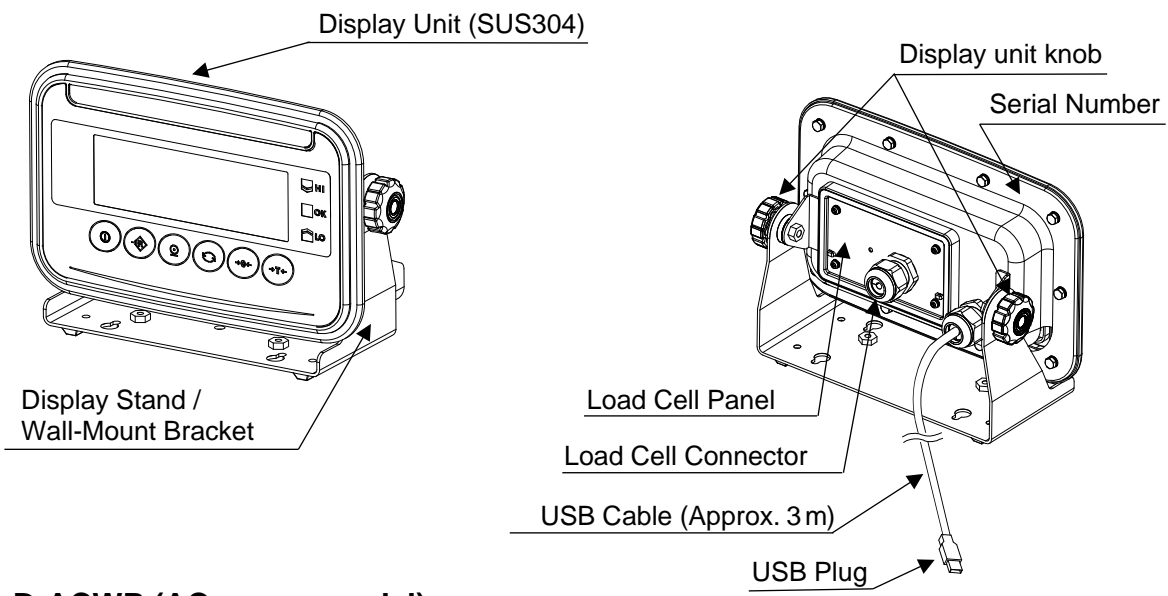

## <FG-D-ACWP (AC power model)>

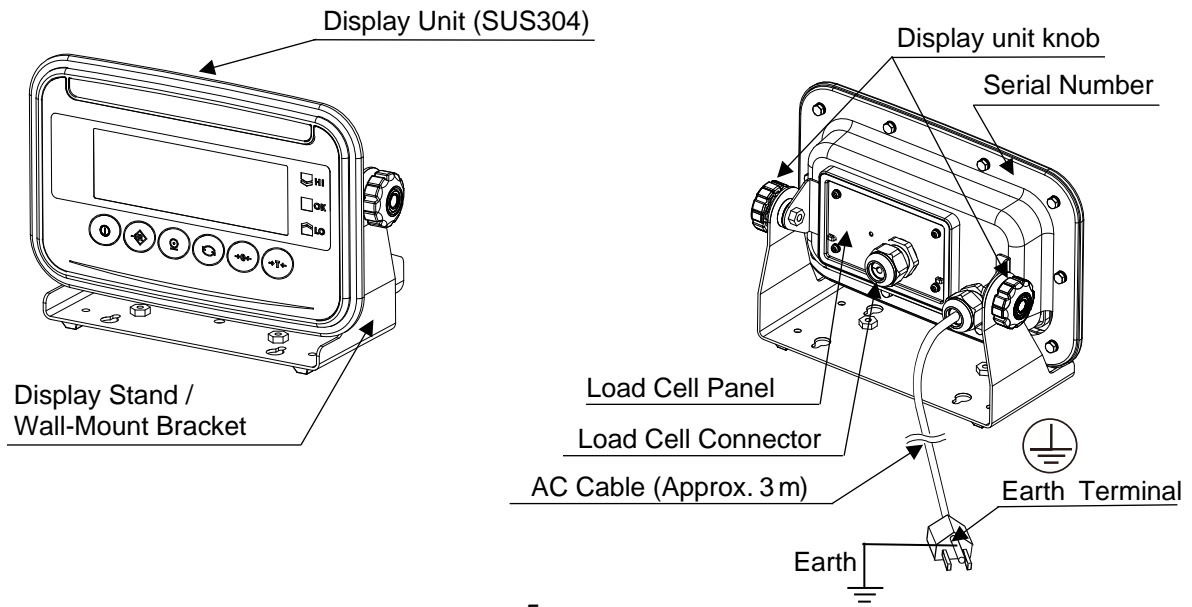



## 4.1. Display and Symbols

Display Unit

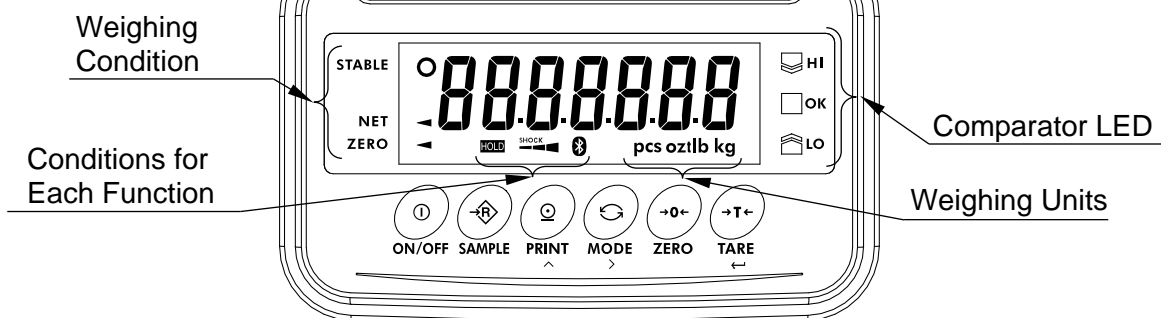

Display/symbol	Description
STABLE ○	This is lit when the weighing value is stable, indicating that the scale is in the proper condition for reading weighing values.
NET ◀	This is lit when weight of the container (tare) is subtracted.
ZERO ◀	This is lit when the scale is at the zero point (reference point for weighing).
Weighing Units	“ kg ”, “ g ”, “ pcs ”, “ oz ”, “ lb ” and “ t ” is lit.
<b>HOLD</b>	This is lit when the display is held.
<b>SHOCK</b>	This is a function to detect impact to the mass sensor section and to display the impact level.
	Turns on when the connection with the wireless communication receiver is established.
  	While the comparator function is being used, the weighing value is compared using the preset threshold values and the indicator displays the result.
	Alternating current.
	Earth (ground) Terminal.

- For details on the method of operation, various functions, function table, etc. refer to the [Instruction Manual: FG-CWP / FG-ACWP Series] on our website (<https://www.aandd.jp>).
- However, please note that functions related to USB and mobile battery cannot be used with FG-D-ACWP (AC power model).



## 4.2. Operation Keys

Operation key	Description
 ON/OFF	<b>ON/OFF Key</b> Shows or hides the display.
 SAMPLE	<b>SAMPLE Key</b> Selecting “pcs” as the unit activates individual weight setting mode. Pressing and holding (for about 2 seconds) activates the comparator threshold setting mode.

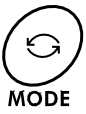
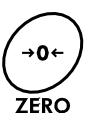
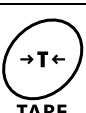
Operation key	Description
 PRINT	<b>PRINT Key</b> Outputs the weighing value as data. Increases the value of the digit flashing when setting.
 MODE	<b>MODE Key</b> Switches the weighing unit. Shifts to the right the digit flashing when making settings.
 ZERO	<b>ZERO Key</b> Based on the zero point weighed at the time of turning on the display, by pressing the ZERO key when the weight value is stable within $\pm 2\%$ of the weighing capacity, the zero point indicator turns on as soon as the display becomes zero.
 TARE	<b>TARE Key</b> The weight of the item on the weighing pan is subtracted as the weight of a container (tare weight).



## 5. Maintenance

- Refer to "3. Cautions" regarding use.
- Refer to "5.3. Error Code Table" and corresponding mode for displayed error code.
- Refer to the [FG-CWP / FG-ACWP Series Instruction Manual] on the A&D website (<https://www.aandd.jp>) for sensitivity adjustment.
- Periodically check the accuracy of weighing. Adjust the scale, if it is moved to another location or the environment has changed.



### 5.1. Repair

Do not disassemble / assemble the scale without an authorized service engineer. Doing so may cause an electric shock or damage to the scale, etc. In this case, repair is not covered under warranty. Contact your local A&D dealer if your scale needs service or repair.

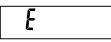
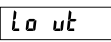
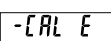
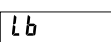

### 5.2. Error display

In this situation	Confirm these items
Nothing displayed. Scale does not turn on.	<ul style="list-style-type: none"> <li>• Is the main power the correct voltage?</li> <li>• Is the main power cord properly connected?</li> </ul>
The scale does not display zero at first.	<ul style="list-style-type: none"> <li>• Check around the weighing pan.</li> <li>• Is there anything on the weighing pan?</li> <li>• Refer to the [FG-D-CWP / FG-D-ACWP Instruction Manual] on the A&amp;D website (<a href="https://www.aandd.jp">https://www.aandd.jp</a>) and perform zero point sensitivity adjustment.</li> </ul>
 is displayed.	• Weighing error that meaning "Over loaded".
 is displayed.	• Indicates that the sample weight is too light to set the unit weight in the counting mode.
 is displayed.	• Sensitivity adjustment error that meaning "Too light".
 is displayed.	• Displayed when the main power drops.

In this situation	Confirm these items
----- is displayed and does not proceed.	<ul style="list-style-type: none"> <li>The weighed value is unstable due to drift, vibration or other factors. A breeze or vibration may be affecting measurement. Check around the weighing pan.</li> <li>Check the connection of the load cell cable.</li> <li>No zero display when the display is turned on. Remove anything that is on the pan.</li> <li>Refer to the [FG-D-CWP / FG-D-ACWP Instruction Manual] on the A&amp;D website (<a href="https://www.aandd.jp">https://www.aandd.jp</a>) and perform zero point sensitivity adjustment.</li> </ul>
Fixed display.	<ul style="list-style-type: none"> <li>Did you use the "hold function" ?</li> <li>Refer to the [FG-CWP / FG-ACWP Series Instruction Manual] on the A&amp;D website (<a href="https://www.aandd.jp">https://www.aandd.jp</a>) and change the function <input type="text" value="Hold"/>.</li> <li>Turn off scale and turn it on again.</li> </ul>



### 5.3. Error Code Table

When any of the following errors are displayed, try turning the display off and on again.

Display	Content
<input type="text" value="Error 0"/> is displayed	The temperature sensor has failed.
<input type="text" value="Error 3"/> is displayed	The memory (circuit) has failed.
<input type="text" value="Error 4"/> is displayed	The internal circuitry has failed.
<input type="text" value="Error 5"/> is displayed	The mass sensor has failed.



## 6. Specifications

- Specifications are subject to change without notice.

Input sensitivity	0.1 $\mu\text{V}/\text{d}$ min. (d: minimum division)
Input signal range	-16 mV to 16 mV
Load cell excitation voltage	5 V $\pm$ 10 %
Load cell drive capacity	Up to 4 x 350 ohm loadcells
Temperature coefficient Zero	$\pm 0.02 \mu\text{V}/^\circ\text{C}$ typ. $\pm 0.1 \mu\text{V}/^\circ\text{C}$ max.
Temperature coefficient Span	$\pm 3 \text{ ppm}/^\circ\text{C}$ typ. $\pm 15 \text{ ppm}/^\circ\text{C}$ max.
linearity	$\pm 0.01$ % of full scale
Maximum display resolution	100,000
Display	7 segment LCD with backlight (Character height 30 mm)
Display update	Approx. 10 times/second
Operating Conditions	-10 $^\circ\text{C}$ to 40 $^\circ\text{C}$ , 85 % R.H. or less (non-condensing)
Installation environment	Indoor use only
Altitude	Altitude up to 2,000 m
Power Supply	<FG-D-CWP (USB power model)> Power supplied from AC adapter, mobile battery, or USB Type-A port USB Cable Length: Approx. 3 m (USB cable is also used for communication.) <FG-D-ACWP (AC power model)> AC mains (100 V to 240 V, 50/60 Hz, 0.1 A Max) AC Cable Length: Approx. 3 m
Overvoltage category *	II
Pollution degree *	2
Dimensions	Width 240 mm x Depth 76 mm x Height 155 mm
Weight (approximately)	1.6 kg (Includes stand)
Dust and water protection	Complies with IP67

\* Applicable to FG-D-ACWP (AC power model) only





# 1. Introduction

Ce guide de démarrage rapide décrit les fonctions et les opérations de base de ce produit.

L'indicateur de pesage FG-D-CWP / FG-D-ACWP peut être utilisé sur une balance plate-forme étanche conforme à l'indice de performance IP67. Ses spécifications et fonctions sont similaires à celles de l'indicateur de la série FG-CWP.

Des informations détaillées sur FG-D-CWP / FG-D-ACWP sont fournies dans le manuel d'instructions suivant. Ces manuels peuvent être téléchargés depuis le site web d'A&D (<https://www.aandd.jp>).



Scannez ce code QR pour ce manuel.

[Manuel d'instructions de FG-D-CWP / FG-D-ACWP]

Ce manuel d'instructions doit être utilisé lors du raccordement de FG-D-CWP / FG-D-ACWP à une plate-forme de pesage (cellule de charge) et de son installation sur cette dernière.







[Manuel d'instructions de la série FG-CWP / FG-ACWP]

Ce manuel d'instructions doit permettre de comprendre et d'exploiter pleinement la balance plate-forme numérique étanche de la série FG-CWP.

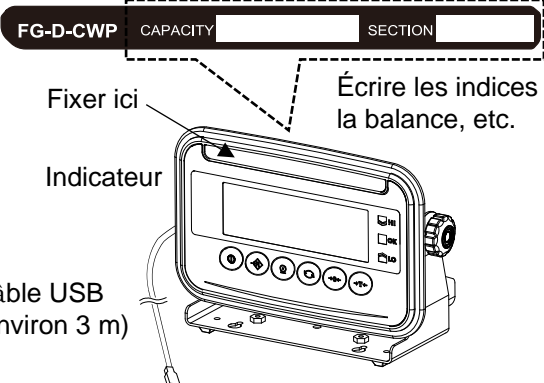

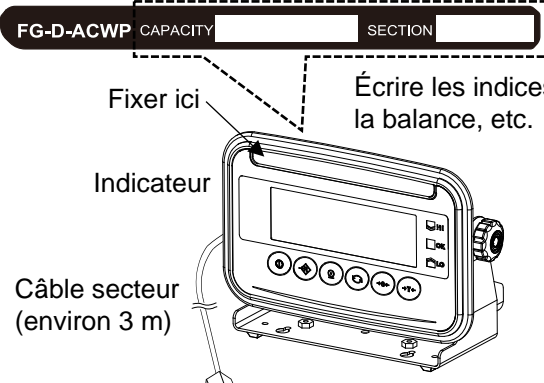
# 2. Articles inclus

Le produit est emballé avec les articles suivants.

FG-D-CWP (Modèle à alimentation USB)	FG-D-ACWP (Modèle à alimentation secteur)
<ul style="list-style-type: none"> <li>• FG-D-CWP               <ul style="list-style-type: none"> <li>Étiquette de modèle (1083039230-1)</li> </ul> </li> </ul>  <p>Écrire les indices de la balance, etc.</p> <p>Indicateur</p> <p>Câble USB (environ 3 m)</p> <ul style="list-style-type: none"> <li>• Adaptateur CA</li> </ul>  <p>(Schéma illustratif)</p>	<ul style="list-style-type: none"> <li>• FG-D-ACWP               <ul style="list-style-type: none"> <li>Étiquette de modèle (1083039230-3)</li> </ul> </li> </ul>  <p>Écrire les indices de la balance, etc.</p> <p>Indicateur</p> <p>Câble secteur (environ 3 m)</p>
<p>※ Accessoires communs FG-D-CWP / FG-D-ACWP</p> <ul style="list-style-type: none"> <li>• Guide de démarrage rapide</li> <li>• Emballage en caoutchouc (diamètre des câbles de la cellule de charge / utilisé en cas d'utilisation de <math>\Phi 3,5</math> à <math>\Phi 7,0</math>)</li> <li>• Pieds en caoutchouc pour le support d'affichage (4 pièces)</li> </ul>   	



## 3. Avertissements



### 3.1. Précautions d'installation de l'indicateur



#### **DANGER**

- Mettre la balance à la terre afin de protéger l'utilisateur des chocs électriques.
- Afin d'éviter les chocs électriques, ne pas manipuler le câble USB/secteur avec les mains mouillées.
- La fiche USB n'est pas résistante à l'eau. Utiliser une prise USB située à un endroit où la fiche ne sera pas mouillée (pour FG-D-CWP (modèle à alimentation USB)).
- La fiche secteur n'est pas résistante à l'eau. Utiliser une prise électrique située à un endroit où la fiche ne sera pas mouillée. (pour FG-D-ACWP (modèle à alimentation secteur))
- Ne pas installer la balance dans un environnement où des gaz inflammables ou corrosifs sont présents.
- Ne pas soumettre les câbles à une force excessive.
- La balance est lourde. Faire preuve de prudence lorsque la balance est soulevée, car elle risque de basculer.
- Utiliser des câbles de cellule de charge blindés.

Lire « Précautions d'installation de la balance » dans [Manuel d'instructions : série FG-CWP / FG-ACWP] sur le site web d'A&D (<https://www.aandd.jp>) pour plus de précautions et d'avertissements sur le montage, le stockage et le nettoyage de la balance.

Lire « Installation et précautions » dans [Manuel d'instructions : FG-D-CWP / FG-D-ACWP] (sur le site web d'A&D (<https://www.aandd.jp>)) pour le raccordement de cellules de charge, l'installation d'indicateurs, le réglage des fonctions et de la sensibilité, etc.



### 3.2. Raccordement de cellules de charge

FG-D-CWP / FG-D-ACWP dispose de deux configurations de raccordement : la configuration à 6 fils et la configuration à 4 fils.

Nous recommandons de raccorder en configuration à 6 fils pour une précision et une stabilité optimales.

Le diamètre applicable du câble de la cellule de charge est compris entre  $\Phi 3,5$  et  $\Phi 9,0$  mm.

La longueur du câble de la cellule de charge doit être inférieure à 30 m. Pour une configuration à 4 fils, nous recommandons d'utiliser une longueur de 5 m ou moins.

N° de borne	Fonction	
1	SIG-	Entrée de la cellule de charge (-)
2	SIG+	Entrée de la cellule de charge (+)
3	EXC-	Tension d'excitation de la cellule de charge (-)
4	SEN-	Entrée de détection (-)
5	SEN+	Entrée de détection (+)
6	EXC+	Tension d'excitation de la cellule de charge (+)
7	SHIELD	Blindage

Cellule de charge Câble

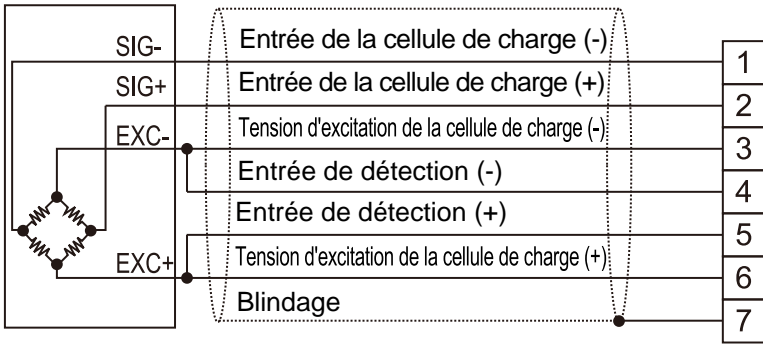

(A) Raccordement en configuration à 6 fils à une cellule de charge (recommandé)

Câble

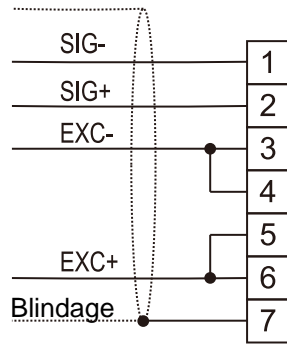

(B) Raccordement en configuration à 4 fils à une cellule de charge

# 4. Noms des pièces

## <FG-D-CWP (Modèle à alimentation USB)>

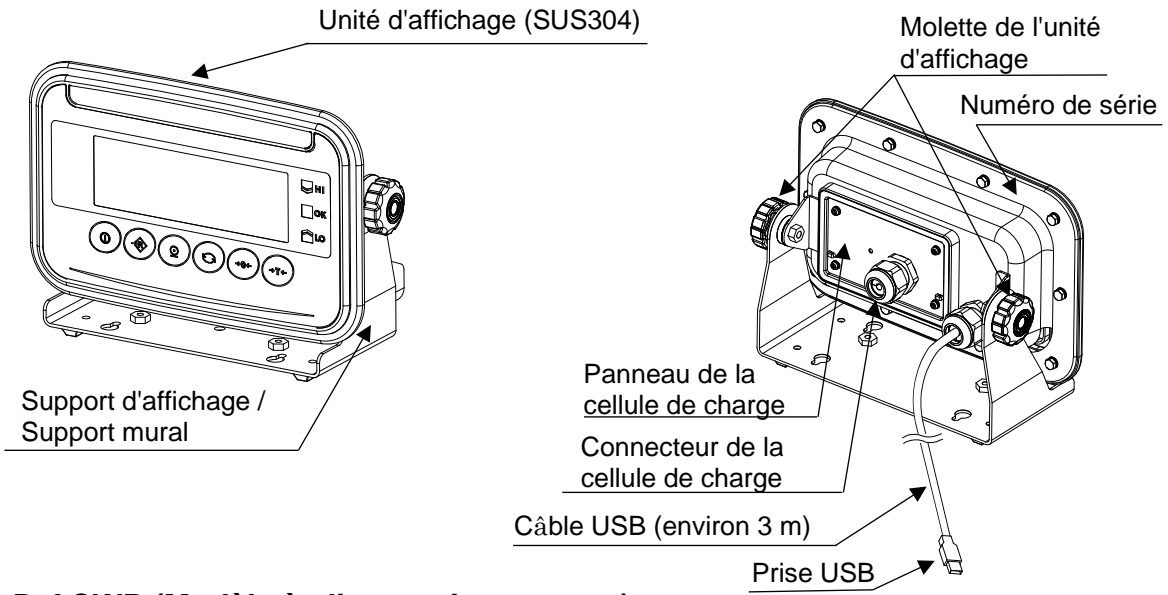

## <FG-D-ACWP (Modèle à alimentation secteur)>

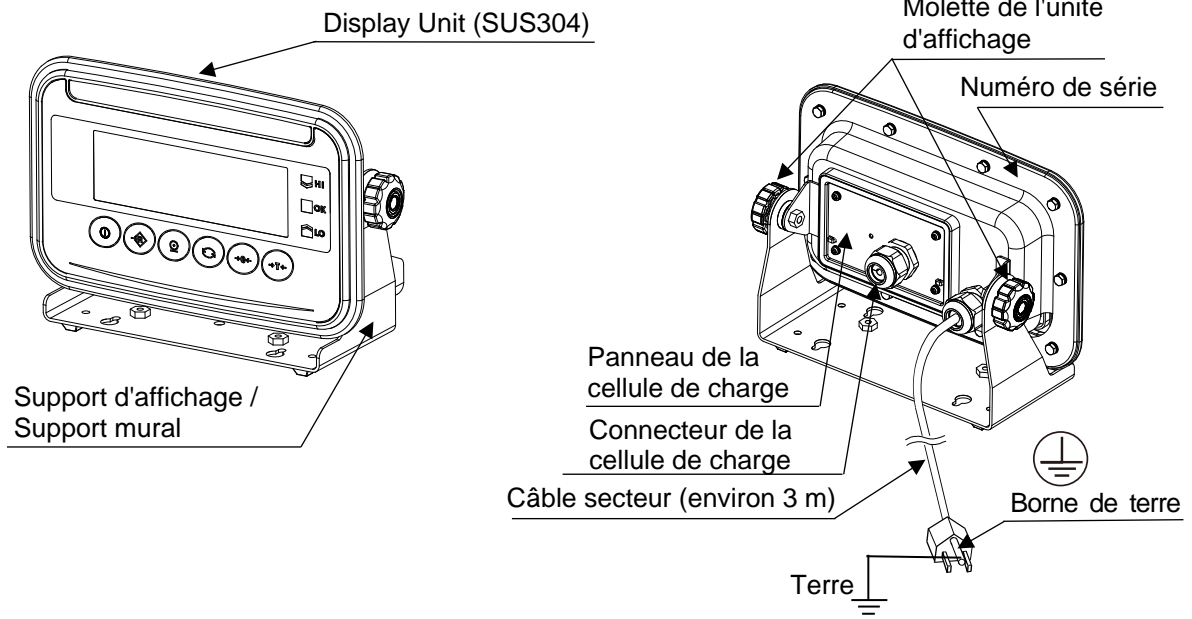



## 4.1. Affichage et symboles

Unité d'affichage

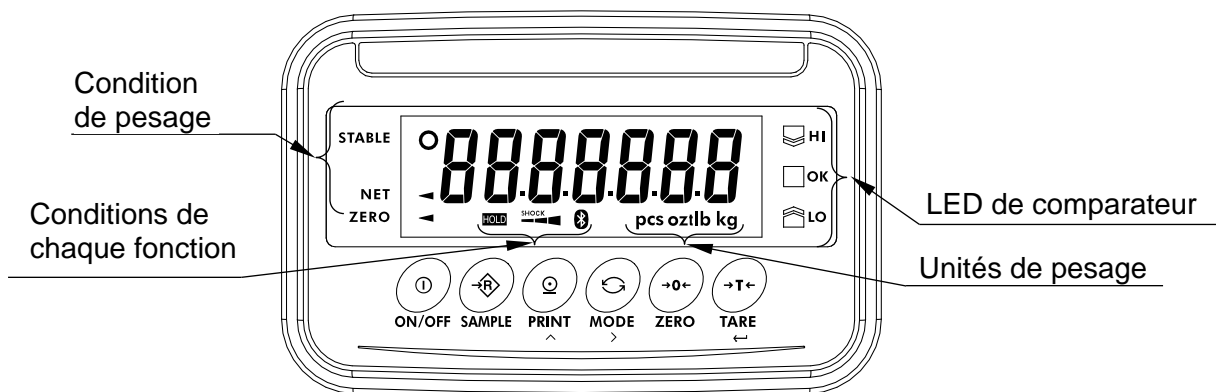

Affichage/symbole	Description
STABLE	Ceci s'allume quand la valeur de pesage est stable afin d'indiquer que la balance dispose des bonnes conditions pour lire les valeurs de pesage.
NET	Ceci s'allume quand le poids du contenant (tare) est soustrait.
ZERO	Ceci s'allume quand la balance se trouve au point zéro (point de référence pour le pesage).
Unités de pesage	« kg », « g », « pcs », « oz », « lb » ou « t » s'allume.
<b>HOLD</b>	Ceci s'allume quand l'affichage est tenu.
<b>SHOCK</b>	Cette fonction sert à détecter l'impact sur la section du capteur de masse et à afficher le niveau d'impact.
	Ceci s'allume quand la connexion est établie avec le récepteur de communication sans fil.
  	Lorsque la fonction de comparateur est utilisée, la valeur de pesage est comparée à l'aide des valeurs de seuil prédéfinies et l'indicateur affiche le résultat.
	Courant alternatif
	Borne de terre

- Pour plus de détails sur la méthode d'utilisation, les différentes fonctions, le tableau des fonctions, etc., se référer au [Manuel d'instructions : série FG-CWP / FG-ACWP] sur notre site Web (<https://www.aandd.jp>).
- Toutefois, veuillez noter que les fonctions liées à l'USB et à la batterie mobile ne peuvent pas être utilisées avec le FG-D-ACWP (modèle à alimentation secteur).



## 4.2. Touches de commande

Touche de commande	Description
 ON/OFF	<b>Touche ON/OFF</b> Affiche ou masque l'affichage.
 SAMPLE	<b>Touche SAMPLE</b> Lors de la sélection de « pcs » comme unité, le mode de réglage individuel du poids est activé. Une pression longue (d'environ 2 secondes) active le mode de réglage du seuil du comparateur.

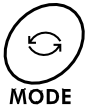
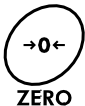
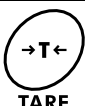
Touche de commande	Description
 PRINT	<b>Touche PRINT</b> Fournit la valeur de pesage sous forme de données. Augmente la valeur du chiffre qui clignote lors du réglage.
 MODE	<b>Touche MODE</b> Change l'unité de pesage. Déplace vers la droite le chiffre qui clignote lors du réglage.
 ZERO	<b>Touche ZERO</b> D'après le point zéro pesé lors du démarrage de l'affichage, lors d'une pression sur la touche ZERO quand la valeur du poids est stable à $\pm 2\%$ de la capacité de pesage, l'indicateur du point zéro s'allume dès que l'affichage passe à zéro.
 TARE	<b>Touche TARE</b> Le poids de l'article posé sur le plateau de pesage est soustrait en tant que poids de contenant (tare).



## 5. Maintenance

- Se référer à « 3. Avertissements » pour l'utilisation.
- Se référer à « 5.3. Tableau des codes d'erreur » et au mode correspondant pour le code d'erreur affiché.
- Se référer à [Manuel d'instructions de la série FG-CWP / FG-ACWP] sur le site web d'A&D (<https://www.aandd.jp>) pour le réglage de la sensibilité.
- Vérifier régulièrement la précision du pesage. Régler la balance si elle a été déplacée dans un nouvel endroit ou si l'environnement a changé.







### 5.1. Réparation

Ne démonter/monter la balance qu'en présence d'un technicien d'entretien agréé. Sinon, l'utilisateur risque de subir un choc électrique ou d'endommager la balance, etc. Dans ce cas, la garantie ne couvre pas la réparation. Contacter le distributeur A&D local si la balance a besoin d'un entretien ou d'une réparation.



### 5.2. Affichage d'erreurs

Dans cette situation	Vérifier ces éléments
Rien ne s'affiche. La balance ne démarre pas.	<ul style="list-style-type: none"> <li>· L'alimentation principale est-elle à la bonne tension ?</li> <li>· Le cordon de l'alimentation principale est-il correctement raccordé ?</li> </ul>
La balance n'affiche pas le zéro en premier.	<ul style="list-style-type: none"> <li>· Vérifier les abords du plateau de pesage.</li> <li>· Y a-t-il quelque chose sur le plateau de pesage ?</li> <li>· Se référer à [Manuel d'instructions de FG-D-CWP / FG-D-ACWP] sur le site web d'A&amp;D (<a href="https://www.aandd.jp">https://www.aandd.jp</a>) et régler la sensibilité du point zéro.</li> </ul>
 s'affiche.	· Erreur de pesage signifiant « Surcharge ».
 s'affiche.	· Indique que le poids d'échantillon est trop léger pour régler le poids de l'unité en mode de comptage.
 s'affiche.	· Erreur de réglage de la sensibilité signifiant « Trop léger ».
 s'affiche.	· S'affiche lorsque l'alimentation principale chute.
 s'affiche et l'affichage ne change pas.	<ul style="list-style-type: none"> <li>· La valeur pesée est instable en raison d'un décalage, de vibrations ou d'autres facteurs.</li> <li>· Une brise ou des vibrations perturbent peut-être la mesure.</li> <li>· Vérifier les abords du plateau de pesage.</li> <li>· Vérifier le raccordement du câble de la cellule de charge.</li> </ul>

Dans cette situation	Vérifier ces éléments
	<ul style="list-style-type: none"> <li>Le zéro ne s'affiche pas lorsque l'affichage est démarré. Retirer tout article éventuellement posé sur le plateau.</li> <li>Se référer à [Manuel d'instructions de FG-D-CWP / FG-D-ACWP] sur le site web d'A&amp;D (<a href="https://www.aandd.jp">https://www.aandd.jp</a>) et régler la sensibilité du point zéro.</li> </ul>
Affichage fixe.	<ul style="list-style-type: none"> <li>La fonction « Hold » a-t-elle été utilisée ? Se référer à [Manuel d'instructions de la série FG-CWP / FG-ACWP] sur le site web d'A&amp;D (<a href="https://www.aandd.jp">https://www.aandd.jp</a>) et modifier la fonction <input type="text" value="Hold"/>.</li> <li>Arrêter la balance, puis la redémarrer.</li> </ul>



### 5.3. Tableau des codes d'erreur

Lorsque l'une des erreurs suivantes s'affiche, essayer d'arrêter l'affichage et de le redémarrer.

Affichage	Contenu
<input type="text" value="Error 0"/> s'affiche	Le capteur de température a dysfonctionné.
<input type="text" value="Error 3"/> s'affiche	La mémoire (circuit) a dysfonctionné.
<input type="text" value="Error 4"/> s'affiche	Les circuits internes ont dysfonctionné.
<input type="text" value="Error 5"/> s'affiche	Le capteur de masse a dysfonctionné.



## 6. Spécifications

- Les spécifications sont sujettes à modifications sans préavis.

Sensibilité d'entrée	0,1 $\mu\text{V/d}$ min. (d : division minimale)
Plage du signal d'entrée	-16 mV à 16 mV
Tension d'excitation de cellule de charge	5 V $\pm$ 10 %
Capacité d'excitation de cellule de charge	Jusqu'à 4 cellules de charge de 350 ohms
Coefficient de température au point zéro	$\pm 0,02 \mu\text{V}/^\circ\text{C}$ typ. $\pm 0,1 \mu\text{V}/^\circ\text{C}$ max.
Coefficient de température sur l'intervalle	$\pm 3 \text{ ppm}/^\circ\text{C}$ typ. $\pm 15 \text{ ppm}/^\circ\text{C}$ max.
Linéarité	$\pm 0,01$ % de la pleine échelle
Résolution d'affichage maximum	100,000
Affichage	LCD 7 segments avec rétroéclairage (hauteur des caractères : 30 mm)
Actualisation de l'affichage	Environ 10 fois/seconde
Conditions de fonctionnement	-10 $^\circ\text{C}$ à 40 $^\circ\text{C}$ , 85 % HR ou moins (sans condensation)
Environnement d'installation	Utilisation en intérieur uniquement
Altitude	Altitude jusqu'à 2 000 m
Alimentation	<p>&lt;FG-D-CWP (modèle à alimentation USB)&gt; Alimentation fournie par l'adaptateur secteur, la batterie mobile ou le port USB de type A. Longueur du câble USB : environ 3 m (Le câble USB est également utilisé pour la communication.)</p> <p>&lt;FG-D-ACWP (modèle à alimentation secteur)&gt; Courant secteur (100 V à 240 V, 50/60 Hz, 0.1 A Max) Longueur du câble secteur : environ 3 m</p>
Catégorie de surtension *	II
Degré de pollution *	2
Dimensions	240 mm de largeur x 76 mm de profondeur x 155 mm de hauteur
Poids (approximatif)	1,6 kg (socle inclus)
Protection contre l'eau et la poussière	Conforme à la norme IP67

\* Applicable uniquement au FG-D-ACWP (modèle à alimentation CA)



# 1. Einführung

In dieser Schnellstartanleitung werden die Grundfunktionen und die Bedienung des Produkts beschrieben.

Die Wägeanzeige FG-D-CWP / FG-D-ACWP kann auf einer wasserfesten Plattformwaage mit IP67-Leistung verwendet werden. Die Spezifikationen und Funktionen ähneln denen der Serie FG-CWP. In den folgenden Bedienungshandbüchern finden Sie detaillierte Informationen über FG-D-CWP / FG-D-ACWP. Diese Handbücher können von der A&D-Webseite (<https://www.aandd.jp>) heruntergeladen werden.

Scannen Sie diesen QR-Code für dieses Handbuch.

[FG-D-CWP / FG-D-ACWP-Bedienungshandbuch]

Dieses Handbuch wird zur Verbindung und Installation von FG-D-CWP an eine Wägeplattform (Wägezelle) verwendet.

[Bedienungshandbuch FG-CWP/ FG- ACWP-Serie]

Dieses Handbuch dient dem Verständnis und der vollständigen Verwendung der wasserdichten digitalen Plattformwaage der FG-Serie.



# 2. Im Packungsumfang enthalten

Die folgenden Elemente werden mit dem Produkt verpackt.

FG-D-CWP (USB-Strom-Modell)	FG-D-ACWP (Netzstrom-Modell)
<ul style="list-style-type: none"> <li>● FG-D-CWP                             <div style="margin-left: 20px;">                                 Modelletikett (1083039230-1)                                 <div style="border: 1px dashed black; padding: 2px; display: inline-block; margin: 5px 0;">                                     FG-D-CWP    CAPACITY    SECTION                                 </div> </div> <div style="margin-left: 20px;"> <p>Hier anbringen</p> <p>Schreiben Sie die Werte der Waage usw. auf.</p> </div> <div style="margin-left: 20px;"> <p>Anzeige</p> <p>USB-Kabel (Ca. 3m)</p> </div> </li> <li>● Wechselstromadapter                             <div style="margin-left: 20px;"> <p>(Bilddiagramm)</p> </div> </li> </ul>	<ul style="list-style-type: none"> <li>● FG-D-ACWP                             <div style="margin-left: 20px;">                                 Modelletikett (1083039230-3)                                 <div style="border: 1px dashed black; padding: 2px; display: inline-block; margin: 5px 0;">                                     FG-D-ACWP    CAPACITY    SECTION                                 </div> </div> <div style="margin-left: 20px;"> <p>Hier anbringen</p> <p>Schreiben Sie die Werte der Waage usw. auf.</p> </div> <div style="margin-left: 20px;"> <p>Anzeige</p> <p>Netzkabel (Ca. 3m)</p> </div> </li> </ul>
<p>※ FG-D-CWP / FG-D-ACWP gemeinsames Zubehör</p> <ul style="list-style-type: none"> <li style="width: 33%; margin-right: 3%; margin-bottom: 10px;">● Schnellstartanleitung</li> <li style="width: 33%; margin-right: 3%; margin-bottom: 10px;">● Gummiverpackung (Wägezellenkabel Durchmesser / Verwendung bei <math>\Phi 3,5</math> bis <math>7,0</math>)</li> <li style="width: 33%; margin-bottom: 10px;">● GummifüÙe für Displayständer (4 Stk.)</li> </ul> <div style="display: flex; justify-content: space-around; align-items: center;"> </div>	





## 3. Vorsichtshinweise



### 3.1. Sicherheitsvorkehrungen zur Installation der -Anzeige



#### GEFAHR

- Erden Sie die Waage, damit der Benutzer keinen elektrischen Schlag erleidet.
- Um einen elektrischen Schock zu vermeiden, berühren Sie das USB-Kabel/Netzkabel nicht mit nassen Händen.
- Der USB-Stecker ist nicht wasserdicht. Verwenden Sie einen USB-Anschluss in einem Bereich, in dem der Stecker nicht nass wird. (Für FG-D-CWP (USB-Strom-Modell))
- Der Netzstecker ist nicht wasserdicht. Verwenden Sie einen Netzanschluss in einem Bereich, in dem der Stecker nicht nass wird. (Für FG-D-ACWP (Netzstrom-Modell))
- Stellen Sie die Waage nicht in einer Umgebung auf, in der entzündliche oder ätzende Gase auftreten.
- Üben Sie keine übermäßige Kraft auf die Kabel aus.
- Die Waage ist schwer. Seien Sie vorsichtig, da sie beim Anheben umfallen kann.
- Verwenden Sie abgeschirmte Wägezellenkabel.

Bitte lesen Sie „Sicherheitsvorkehrungen zur Installation der Waage“ in [Bedienungshandbuch: FG-CWP / FG-D-ACWP Serie ] auf der A&D-Website (<https://www.aandd.jp>) für weitere Sicherheitsvorkehrungen, Vorsichtshinweise als montierte Waage, Lagerung und Reinigung.

Bitte lesen Sie „Installation und Vorsichtsmaßnahmen“ in [Bedienungshandbuch: FG-D-CWP / FG-D-ACWP] auf der A&D-Website (<https://www.aandd.jp>) zur Verbindung von Wägezellen, Installation von Anzeigen, für Funktionseinstellungen und Empfindlichkeitseinstellungen usw.



### 3.2. Verbindung von Wägezellen

FG-D-CWP / FG-D-ACWP hat zwei Konfigurationen: die 6-Draht-Konfiguration und die 4-Draht-Konfiguration.

Wir empfehlen die Verbindung mit der 6-Draht-Konfiguration für optimale Genauigkeit und Stabilität.

Der zulässige Durchmesser des Wägezellenkabels beträgt von  $\varnothing 3,5$  bis  $\varnothing 9,0$  mm.

Die Länge des Wägezellenkabels soll weniger als 30 m betragen. Bei einer Konfiguration mit 4 Adern empfehlen wir eine Länge von bis zu 5 m.

Anschluss Nr.	Funktion	
1	SIG-	Wägezellen-Eingang (-)
2	SIG+	Wägezellen-Eingang (+)
3	EXC-	Wägezellen-Erregerspannung (-)
4	SEN-	Sensoreingang (-)
5	SEN+	Sensoreingang (+)
6	EXC+	Wägezellen-Erregerspannung (+)
7	ABSCHIRMUNG	Abschirmung



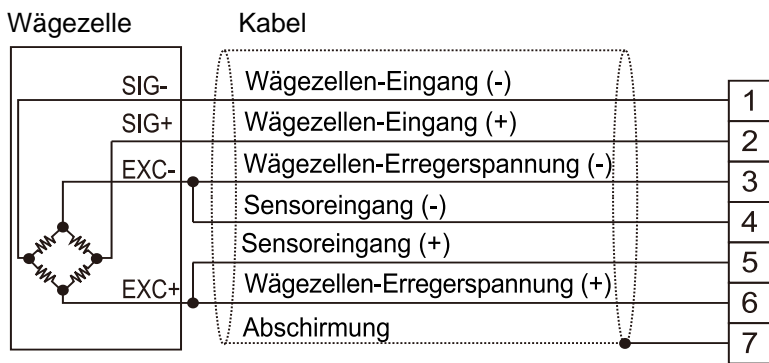

(A) 6-Draht-Konfigurationsverbindung zur Wägezelle (empfohlen)

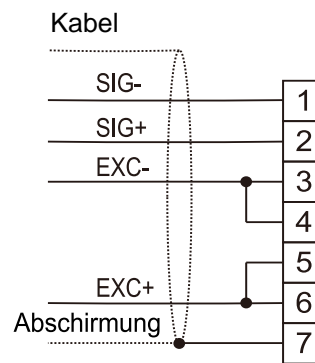

(B) 4-Draht-Konfigurationsverbindung Verbindung zu Wägezelle



## 4. Teilennamen

### <FG-D-CWP (USB-Strom-Modell)>

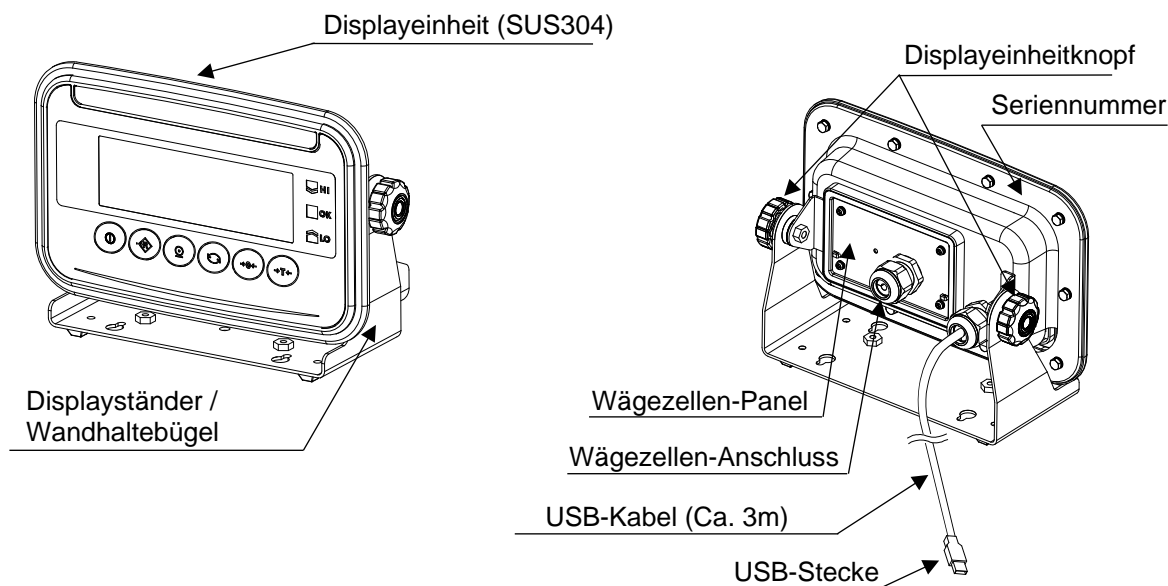

### <FG-D-ACWP (Netzstrom-Modell)>

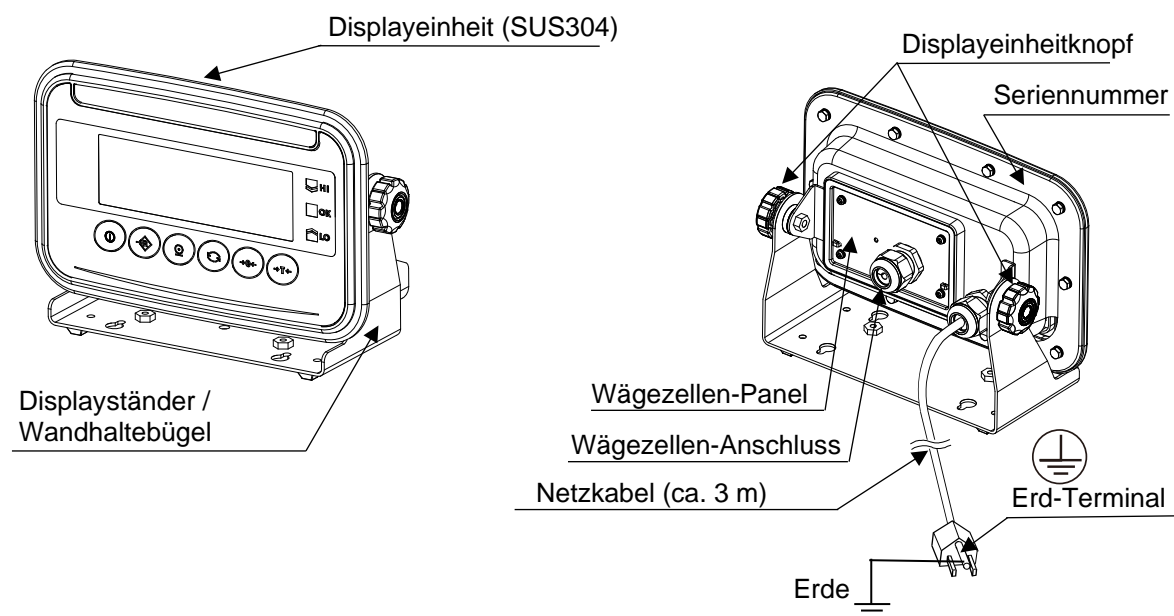



## 4.1. Display und Symbole

Displayeinheit

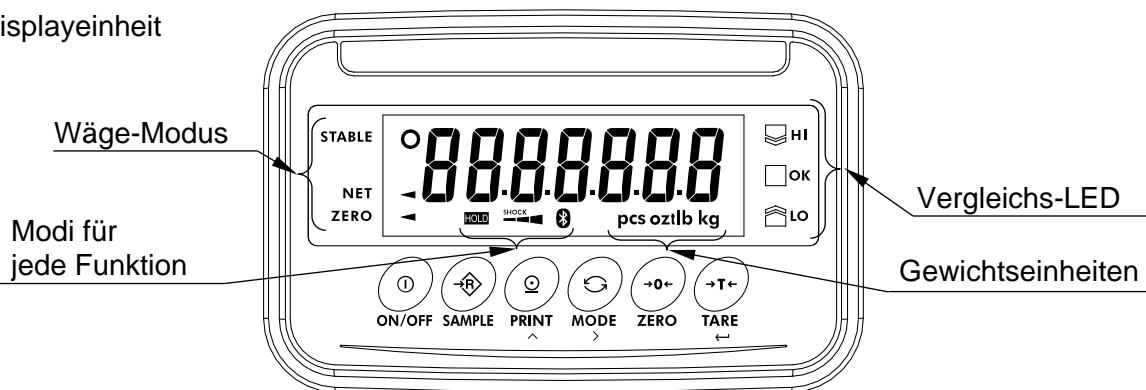

Display/Symbol	Beschreibung
STABLE ○	Diese Anzeige leuchtet, wenn der Gewichtswert stabil ist. Dadurch wird angezeigt, dass die Waage im geeigneten Zustand zum Lesen von Gewichtswerten ist.
NET ◀	Diese Anzeige leuchtet, wenn das Gewicht des Containers (Eigengewicht) abgezogen wird.
ZERO ◀	Diese Anzeige leuchtet, wenn die Waage sich im Nullpunkt (Referenzpunkt zum Wiegen) befindet.
Gewichtseinheiten	„ kg “, „ g “, „ pcs “, „ oz “, „ lb “ und „ t “ leuchten.
<b>HOLD</b>	Es leuchtet, wenn das Display gehalten wird.
<b>SHOCK</b>	Diese Funktion erkennt Stöße auf den Massensensor und zeigt den Stoßgrad an.
	Leuchtet, wenn die Verbindung mit dem kabellosen Kommunikationsempfänger hergestellt ist.
HI OK LO	Während die Vergleichsfunktion verwendet wird, wird der Gewichtswert mit den voreingestellten Schwellenwerten verglichen und die Anzeige zeigt das Gewicht an.
	Wechselstrom
	Erdungsanschluss

- Einzelheiten zur Bedienmethode, Funktionen sowie eine Funktionstabelle finden Sie in [Bedienungshandbuch: FG-CWP / FG-ACWP-Serie] auf unserer Website (<https://www.aandd.jp>).
- Bitte beachten Sie jedoch, dass Funktionen im Zusammenhang mit USB und mobilem Akku nicht mit FG-D-ACWP (Netzstrom-Modell) verwendet werden können.



## 4.2. Bedienungstasten

Bedienungstaste	Beschreibung
 ON/OFF	<b>ON/OFF-Taste</b> Das Display wird angezeigt oder ausgeblendet.
 SAMPLE	<b>SAMPLE-Taste</b> Durch die Auswahl von „pcs“ als Einheit wird der individuelle Gewichtseinstellungsmodus aktiviert. Durch Gedrückthalten (für etwa 2 Sekunden) wird der Vergleichs-Schwellenwerteeinstellmodus aktiviert.

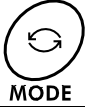
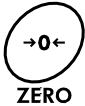
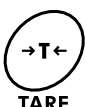
Bedienungstaste	Beschreibung
 PRINT	<b>PRINT-Taste</b> Gibt den Gewichtswert als Daten aus. Erhöht den Wert der Ziffer, die bei der Einstellung aufblinkt.
 MODE	<b>MODE-Taste</b> Wechselt die Gewichtseinheit. Springt zur rechten Ziffer, die aufblinkt, wenn Einstellungen vorgenommen werden.
 ZERO	<b>ZERO-Taste</b> Ausgehend von dem zum Zeitpunkt des Einschaltens der Anzeige gewogenen Nullpunkt wird durch Drücken der Taste ZERO der Nullpunktanzeiger eingeschaltet, sobald die Anzeige auf Null geht, wenn der Gewichtswert innerhalb von $\pm 2$ % des Wägebereichs stabil ist.
 TARE	<b>TARE-Taste</b> Das Gewicht des Gegenstands auf der Waageschale wird als Gewicht eines Containers (Eigengewicht) abgezogen.



## 5. Wartung

- Siehe "3. Vorsichtshinweise" für Informationen zur Verwendung.
- Siehe "5.3 Fehlercode-Tabelle" und den entsprechenden Modus für den angezeigten Fehlercode.
- Siehe [Bedienungshandbuch FG-CWP / FG-ACWP -Serie] auf der A&D-Website (<https://www.aandd.jp>) zur Empfindlichkeitseinstellung.
- Prüfen Sie regelmäßig die Genauigkeit der Waage. Passen Sie die Waage an, wenn sie an einen anderen Ort bewegt wurde oder sich die Umgebung verändert hat.



### 5.1. Reparatur

Nehmen Sie die Waage nicht auseinander und setzen Sie die Waage nicht zusammen ohne einen autorisierten Service-Techniker. Dies kann zu einem elektrischen Schock oder Schäden an der Waage usw. führen. In diesem Fall ist die Reparatur nicht von der Garantie abgedeckt. Wenden Sie sich an ihren lokalen A&D-Händler, wenn Ihre Waage gewartet oder repariert werden muss.

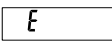
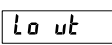
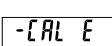
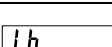

### 5.2. Fehleranzeige

In dieser Situation	Bestätigen Sie folgendes
Nichts wird angezeigt. Die Waage lässt sich nicht einschalten.	<ul style="list-style-type: none"> <li>• Hat der Hauptstrom die korrekte Spannung?</li> <li>• Ist das Hauptstromkabel ordnungsgemäß angeschlossen?</li> </ul>
Die Waage zeigt am Anfang keine Null an.	<ul style="list-style-type: none"> <li>• Prüfen Sie die Umgebung der Waagschale.</li> <li>• Befindet sich etwas auf der Waagschale?</li> <li>• Siehe [Bedienungshandbuch FG-D-CWP / FG-D-ACWP-Serie] auf der A&amp;D-Website (<a href="https://www.aandd.jp">https://www.aandd.jp</a>) und führen Sie die Einstellung der Nullpunktempfindlichkeit durch.</li> </ul>
 wird angezeigt.	• Wäge-Fehler, der „Überladen“ bedeutet.
 wird angezeigt.	• Zeigt an, dass das Gewicht der Probe zu leicht ist, um das Einheitsgewicht im Zählmodus einzustellen.
 wird angezeigt.	• Empfindlichkeitseinstellungsfehler, der bedeutet „zu leicht“.
 wird angezeigt.	• Wird angezeigt, wenn der Hauptstrom ausfällt.

In dieser Situation	Bestätigen Sie folgendes
<div style="border: 1px solid black; padding: 2px; display: inline-block;">-----</div> wird angezeigt und fährt nicht fort.	<ul style="list-style-type: none"> <li>• Der gewogene Wert ist wegen Verschiebungen, Vibrationen oder anderen Faktoren instabil. Ein Windzug oder Vibrationen beeinflussen möglicherweise die Messung. Prüfen Sie die Umgebung der Waagschale.</li> <li>• Prüfen Sie die Verbindung des Wägezellenkabels.</li> <li>• Keine Null-Anzeige, wenn das Display eingeschaltet wird. Entfernen Sie jegliche Gegenstände von der Schale.</li> <li>• Siehe [Bedienungshandbuch FG-D-CWP / FG-D-ACWP-Serie] auf der A&amp;D-Website (<a href="https://www.aandd.jp">https://www.aandd.jp</a>) und führen Sie die Einstellung der Nullpunktempfindlichkeit durch.</li> </ul>
Repariertes Display.	<ul style="list-style-type: none"> <li>• Haben Sie die „Haltefunktion“ verwendet? Siehe [Bedienungshandbuch FG-CWP / FG-ACWP-Serie] auf der A&amp;D-Website (<a href="https://www.aandd.jp">https://www.aandd.jp</a>) und ändern Sie die Funktion <span style="border: 1px solid black; padding: 0 2px;">Hold</span>.</li> <li>• Schalten Sie die Waage aus und wieder ein.</li> </ul>



### 5.3. Fehlercode-Tabelle

Falls einer der folgenden Fehler angezeigt wird, versuchen Sie, das Display aus- und wieder einzuschalten.

Anzeige	Inhalt
<span style="border: 1px solid black; padding: 0 2px;">Error 0</span> wird angezeigt	Der Temperatursensor ist fehlgeschlagen.
<span style="border: 1px solid black; padding: 0 2px;">Error 3</span> wird angezeigt	Der Speicher (Schaltkreis) ist fehlgeschlagen.
<span style="border: 1px solid black; padding: 0 2px;">Error 4</span> wird angezeigt	Der interne Schaltkreis ist fehlgeschlagen.
<span style="border: 1px solid black; padding: 0 2px;">Error 5</span> wird angezeigt	Der Massensensor ist fehlgeschlagen.



## 6. Spezifikationen

- Die Spezifikationen können ohne vorherige Anmeldung verändert werden.

Eingangsempfindlichkeit	0,1 $\mu\text{V/d}$ min. (d: Mindestteilung)
Eingangssignalbereich	-16 mV bis 16 mV
Wägezellen-Erregerspannung	5 V $\pm$ 10 %
Antriebsleistung der Wägezelle	Bis zu 4 x 350 ohm Wägezellen
Temperaturkoeffizient Null	$\pm 0,02 \mu\text{V}/^\circ\text{C}$ typ. $\pm 0,1 \mu\text{V}/^\circ\text{C}$ max.
Temperaturkoeffizient Messspanne	$\pm 3 \text{ ppm}/^\circ\text{C}$ typ. $\pm 15 \text{ ppm}/^\circ\text{C}$ max.
Linearität	$\pm 0,01$ % des Messbereichsendwerts
Maximale Displayauflösung	100000
Anzeige	7-Segment-LED mit Hintergrundlicht (Buchstabengröße 30 mm)
Display-Update	Ca. 10-mal/Sekunde
Betriebsbedingungen	-10 $^\circ\text{C}$ bis 40 $^\circ\text{C}$ , 85 % R.F. oder weniger (nicht kondensierend)
Installationsumgebung	Nur Innen benutzen
Höhe	Höhenlage bis 2.000 m
Stromversorgung	<FG-D-CWP (USB-Strom-Modell)> Wechselstromadapter, mobiler Akku oder USB Typ-A-Anschluss USB-Kabellänge: Ca. 3 m (Das USB-Kabel wird auch zur Kommunikation verwendet.) <FG-D-ACWP (Netzstrom-Modell)> Netzstrom (100 V bis 240 V, 50/60 Hz, 0,1 A max.) Netzkabellänge: Ca. 3 m
Überspannungskategorie *	II
Verschmutzungsgrad *	2
Maße	Breite 240 mm x Tiefe 76 mm x Höhe 155 mm
Gewicht (ungefähr)	1,6 kg (inklusive Ständer)
Staub- und Wasser- Schutz	Konform mit IP67

\* Gilt nur für FG-D-ACWP (Wechselstrommodell).



# 1. Introducción

Esta guía de inicio rápido describe las funciones y operaciones básicas de este producto.

El indicador de pesaje FG-D-CWP / FG-D-ACWP se puede utilizar en una báscula de plataforma a prueba de agua con certificación IP67. Tiene especificaciones y funciones similares a un indicador de la serie FG-CWP. Los siguientes manuales de instrucciones proporcionan información detallada sobre el FG-D-CWP / FG-D-ACWP.

Dichos manuales se pueden descargar del sitio web de A&D (<https://www.aandd.jp>).



Escanee este código QR para obtener este manual.



[Manual de instrucciones del FG-D-CWP / FG-D-ACWP] Este manual de instrucciones se utiliza para conectar e instalar el FG-D-CWP / FG-D-ACWP a una plataforma de pesaje (célula de carga).

[Manual de instrucciones de la serie FG-CWP / FG-ACWP] Este es un manual para comprender y utilizar plenamente la báscula de plataforma digital a prueba de agua de la serie FG-CWP.



# 2. Elementos incluidos

El producto viene con los siguientes elementos.

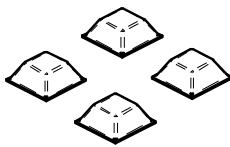
FG-D-CWP (Modelo con alimentación por USB)	FG-D-ACWP (Modelo con alimentación de CA)
<ul style="list-style-type: none"> <li>● FG-D-CWP                             <div style="margin-left: 20px;">                                 Etiqueta del modelo (1083039230-1)                                 <div style="border: 1px dashed black; padding: 2px; display: inline-block; margin: 5px 0;">                                     FG-D-CWP    CAPACITY    SECTION                                 </div> </div> <div style="margin-left: 20px;">                                 Montar aquí <span style="margin-left: 100px;">Escriba los valores de la báscula, etc.</span> </div> <div style="margin-left: 20px;">                                 Indicador                             </div> <div style="margin-left: 20px;">                                 Cable USB (3 m aprox.)                             </div> </li> <li>● Adaptador de CA                             <div style="margin-left: 20px;">  <span style="margin-left: 10px;">(Esquema de la imagen)</span> </div> </li> </ul>	<ul style="list-style-type: none"> <li>● FG-D-ACWP                             <div style="margin-left: 20px;">                                 Etiqueta del modelo (1083039230-3)                                 <div style="border: 1px dashed black; padding: 2px; display: inline-block; margin: 5px 0;">                                     FG-D-ACWP    CAPACITY    SECTION                                 </div> </div> <div style="margin-left: 20px;">                                 Montar aquí <span style="margin-left: 100px;">Escriba los valores de la báscula, etc.</span> </div> <div style="margin-left: 20px;">                                 Indicador                             </div> <div style="margin-left: 20px;">                                 Cable de CA (3 m aprox.)                             </div> </li> </ul>
※ Accesorios comunes para FG-D-CWP / FG-D-ACWP	
<ul style="list-style-type: none"> <li style="width: 33%; margin-right: 3%; margin-bottom: 10px;">                     ● Guía de inicio rápido                     <div style="margin-left: 10px;">  </div> </li> <li style="width: 33%; margin-right: 3%; margin-bottom: 10px;">                     ● Embalaje de goma (cables de la célula de cargadiámetro / Utilizado cuando se usa un flujo magnético de 3,5 a 7,0 Φ)                     <div style="margin-left: 10px;">  </div> </li> <li style="width: 33%;">                     ● Patas de goma para el soporte de la pantalla (4 pzas.)                     <div style="margin-left: 10px;">  </div> </li> </ul>	



## 3. Medidas de precaución



### 3.1. Medidas de precaución para la instalación del indicador



#### PELIGRO

- Conecte la báscula a tierra para evitar que el usuario quede expuesto a una descarga eléctrica.
- Para evitar descargas eléctricas, no maneje el cable USB / cable de CA con las manos mojadas.
- El conector USB no es resistente al agua. Utilice una toma USB ubicada en un lugar en el que el conector no se pueda mojar. (Para FG-D-CWP (modelo con alimentación por USB))
- El conector de CA no es resistente al agua. Utilice una toma eléctrica ubicada en un lugar en el que el conector no se pueda mojar. (Para FG-D-ACWP (modelo con alimentación de CA))
- No instale la báscula donde haya gas inflamable o corrosivo.
- No ejerza demasiada fuerza sobre los cables.
- La báscula es pesada. Tenga cuidado, ya que si la levanta se puede caer.
- Utilice cables apantallados para célula de carga.

Lea “Medidas de precaución para la instalación de la báscula” en [Manual de instrucciones: Serie FG-CWP /FG-ACWP] en el sitio web de A&D (<https://www.aandd.jp>) para obtener información sobre otras medidas de precaución para el montaje de la báscula, el almacenamiento y la limpieza.

Lea “Instalación y medidas de precaución” en [Manual de instrucciones: FG-D-CWP / FG-D-ACWP] en el sitio web de A&D (<https://www.aandd.jp>) para obtener información sobre la conexión de las células de carga, la instalación de los indicadores, los ajustes de función, el ajuste de la sensibilidad, etc.



### 3.2. Conexión de la célula de carga

El FG-D-CWP / FG-D-ACWP cuenta con dos configuraciones de conexión: la configuración de 6 cables y la configuración de 4 cables.

Recomendamos la conexión utilizando la configuración de 6 cables para una precisión y estabilidad óptimas.

El diámetro aplicable del cable de la célula de carga es de entre 3,5 φ y 9,0 φ mm.

La longitud del cable de la célula de carga debería ser inferior a 30 m. Para la configuración de 4 cables recomendamos utilizar uno de 5 m o menos.

N.º de terminal	Función	
1	SIG-	Entrada de la célula de carga (-)
2	SIG+	Entrada de la célula de carga (+)
3	EXC-	Voltaje de excitación de la célula de
4	SEN-	Entrada de detección (-)
5	SEN+	Entrada de detección (+)
6	EXC+	Voltaje de excitación de la célula de
7	SHIELD	Protector

Célula de carga

Cable

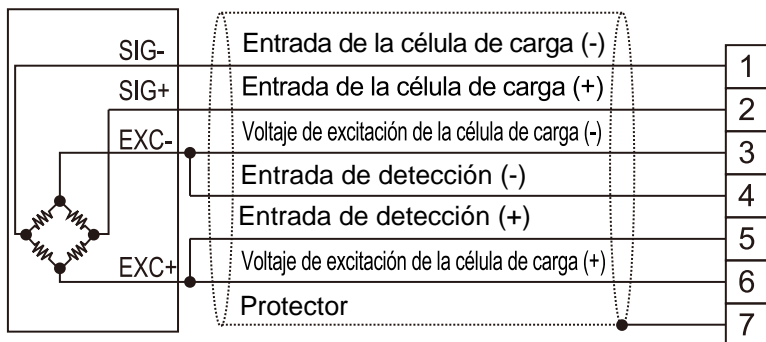

(A) Conexión a la célula de carga con configuración de conexión de 6 cables (recomendado)

Cable

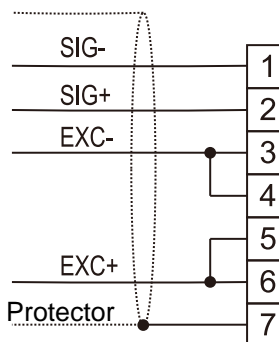

(B) Conexión a la célula de carga con configuración de conexión de 4 cables



## 4. Nombre de las piezas

### <FG-D-CWP (Modelo con alimentación por USB)>

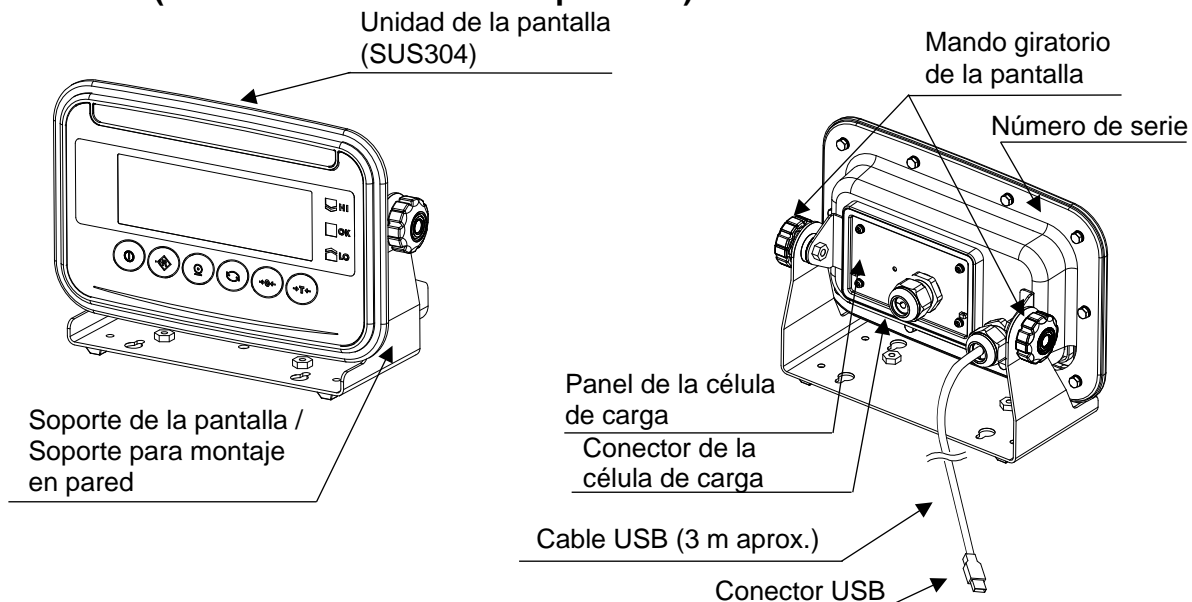

### <FG-D-ACWP (Modelo con alimentación de CA)>

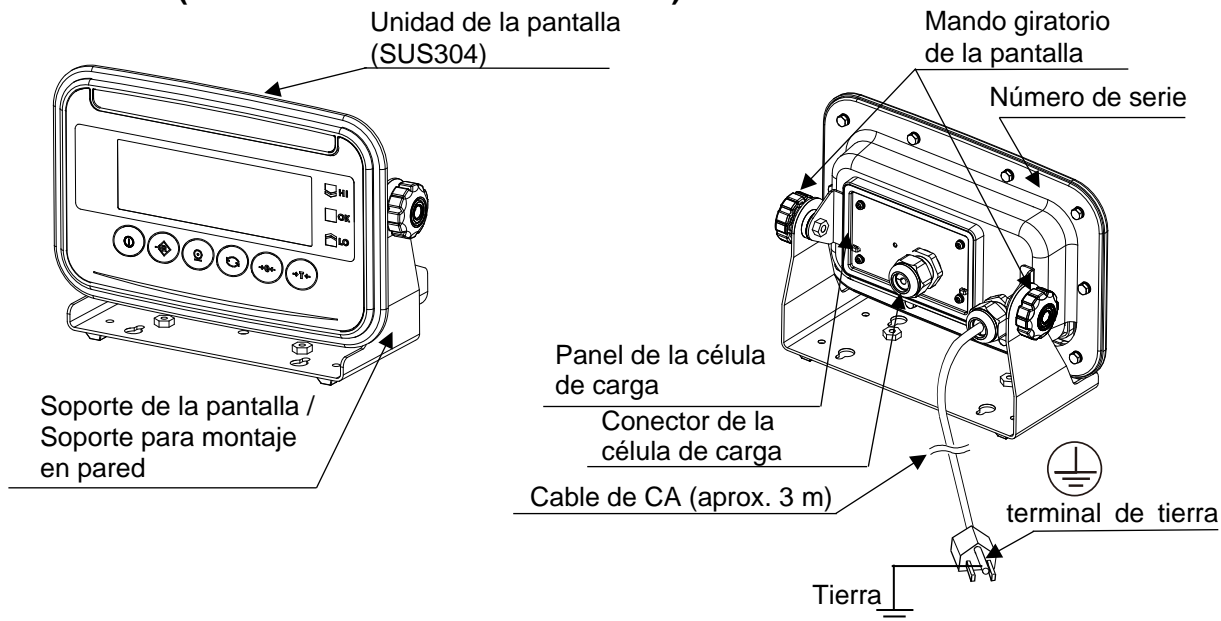





## 4.1. Pantalla y símbolos

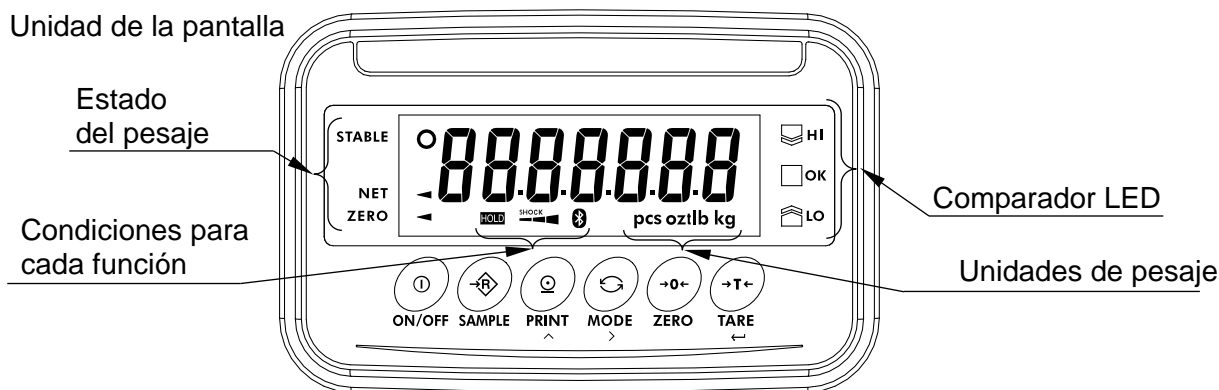

Pantalla/símbolo	Descripción
STABLE ○	Se enciende cuando el valor de pesaje es estable e indica que la báscula está en las condiciones adecuadas para la lectura de valores de pesaje.
NET ◀	Se enciende cuando se resta el peso del recipiente (tara).
ZERO ◀	Se enciende cuando la balanza está en el punto cero (punto de referencia para el pesaje).
Unidades de pesaje	“ kg ”, “ g ”, “ pcs ”, “ oz ”, “ lb ” y “ t ” están encendidos.
<b>HOLD</b>	Se enciende cuando se sostiene la pantalla.
<b>SHOCK</b>	Esta función detecta el impacto en la sección del sensor de masa y mostrar el nivel de impacto.
	Se enciende cuando se establece la conexión con el receptor de comunicación inalámbrica.
HI OK LO	Cuando se usa la función de comparador, el valor de pesaje se compara usando los valores umbrales preestablecidos y el indicador muestra el resultado.
	Corriente alterna.
	Terminal de tierra.





- Para más información sobre el método de operación, las distintas funciones, la tabla de funciones, etc., consulte el [Manual de instrucciones: serie FG-CWP / FG-ACWP] en nuestro sitio web (<https://www.aandd.jp>).
- Sin embargo, tenga en cuenta que las funciones relacionadas con el USB y la batería móvil no se pueden utilizar con FG-D-ACWP (modelo con alimentación de CA).



## 4.2. Operaciones de las teclas

Operación de la tecla	Descripción
 ON/OFF	<b>Tecla ON/OFF</b> Muestra u oculta la pantalla.
 SAMPLE	<b>Tecla SAMPLE</b> Al seleccionar “pcs” como la unidad, se activa el modo de ajuste de peso individual. Mantener pulsado (durante unos 2 segundos) activa el modo ajuste del umbral del comparador.

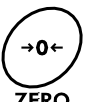

Operación de la tecla	Descripción
 PRINT	<b>Tecla PRINT</b> Envía el valor de pesaje como datos. Aumenta el valor del dígito que parpadea durante el ajuste.
 MODE	<b>Tecla MODE</b> Cambia la unidad de pesaje. Desplaza a la derecha el dígito que parpadea al realizar los ajustes.
 ZERO	<b>Tecla ZERO</b> Según el punto cero pesado en el momento de encender la pantalla, al pulsar la tecla ZERO cuando el valor de peso es estable dentro de $\pm 2\%$ de la capacidad de pesaje, el indicador de punto cero se enciende en cuanto la pantalla se pone a cero.
 TARE	<b>Tecla TARE</b> El peso del elemento en el plato de pesaje se resta como el peso de un recipiente (peso tara).



## 5. Mantenimiento

- Consultar “3. Medidas de precaución” para obtener información sobre el uso.
- Consultar “5.3. Tabla de códigos de error” y el modo correspondiente para el código de error mostrado.
- Consulte el [Manual de instrucciones de la serie FG-CWP / FG-ACWP] en el sitio web A&D (<https://www.aandd.jp>) para obtener información sobre el ajuste de sensibilidad.
- Compruebe periódicamente la precisión del pesaje. Ajuste la báscula si se ha movido a otra ubicación o si el entorno ha cambiado.



### 5.1. Reparación

No desmonte/monte la báscula sin la presencia de un técnico autorizado. Si lo hace, puede provocar una descarga eléctrica, dañar la báscula, etc. En tal caso, la garantía no cubre la reparación. Póngase en contacto con su distribuidor local de A&D si su báscula necesita mantenimiento o reparación.



### 5.2. Visualización de errores

En esta situación	Confirme estos elementos
No se muestra nada. La báscula no se enciende.	<ul style="list-style-type: none"> <li>• ¿El voltaje de la alimentación principal es el correcto?</li> <li>• ¿Está conectado correctamente el cable de alimentación principal?</li> </ul>
La báscula no muestra cero al inicio.	<ul style="list-style-type: none"> <li>• Compruebe el entorno del plato de pesaje.</li> <li>• ¿Hay algo en el plato de pesaje?</li> <li>• Consulte el [Manual de instrucciones del FG-D-CWP / FG-D-ACWP] en el sitio web de A&amp;D (<a href="https://www.aandd.jp">https://www.aandd.jp</a>) y realice el ajuste de sensibilidad del punto cero.</li> </ul>
Se muestra <input type="text" value="E"/>	• Error de pesaje que significa “Sobrecarga”.
Se muestra <input type="text" value="Lo ut"/>	• Indica que el peso de la muestra es demasiado ligero para establecer el peso de la unidad en el modo de recuento.
Se muestra <input type="text" value="-LAL E"/>	• Error de ajuste de sensibilidad que significa “Demasiado baja”.
Se muestra <input type="text" value="Lb"/>	• Aparece cuando la alimentación principal se corta.
Se muestra <input type="text" value="-----"/> y no continúa.	<ul style="list-style-type: none"> <li>• El valor pesado es inestable debido a la oscilación, la vibración y otros factores. Una corriente de aire o una vibración pueden estar afectando a la medición.</li> <li>• Compruebe el entorno del plato de pesaje.</li> <li>• Compruebe la conexión del cable de la célula de carga.</li> <li>• No se muestra cero cuando la pantalla se enciende. Retire cualquier elemento del plato.</li> <li>• Consulte el [Manual de instrucciones del FG-D-CWP] en el sitio web de A&amp;D (<a href="https://www.aandd.jp">https://www.aandd.jp</a>) y realice el ajuste de sensibilidad del punto cero.</li> </ul>

En esta situación	Confirme estos elementos
Pantalla fija.	<ul style="list-style-type: none"> <li>¿Ha utilizado la "función hold"?</li> <li>Consulte el [Manual de instrucciones de la serie FG-CWP / FG-ACWP] en el sitio web A&amp;D (<a href="https://www.aandd.jp">https://www.aandd.jp</a>) y cambie la función <input type="text" value="Hold"/>.</li> <li>Apague la báscula y vuelva a encenderla.</li> </ul>



### 5.3. Tabla de códigos de error

Cuando se muestra alguno de los siguientes códigos de error, pruebe apagar la pantalla y volver a encenderla.

Pantalla	Contenido
Se muestra <input type="text" value="Error 0"/>	Fallo en el sensor de temperatura.
Se muestra <input type="text" value="Error 3"/>	Fallo en la memoria (circuito).
Se muestra <input type="text" value="Error 4"/>	Fallo en el sistema interno de circuitos.
Se muestra <input type="text" value="Error 5"/>	Fallo en el sensor de masa.



## 6. Especificaciones

- Las especificaciones están sujetas a cambio sin previo aviso.

Sensibilidad de entrada	0.1 $\mu\text{V/d}$ min. (d: división mínima)
Intervalo de la señal de entrada	De -16 mV a 16 mV
Voltaje de excitación de la célula de carga	5 V $\pm$ 10 %
Capacidad de resistencia de la célula de carga	Hasta 4 células de carga de 350 ohmios
Coefficiente de temperatura cero	$\pm 0.02 \mu\text{V}/^\circ\text{C}$ típ. $\pm 0.1 \mu\text{V}/^\circ\text{C}$ máx.
Intervalo de coeficiente de temperatura	$\pm 3 \text{ ppm}/^\circ\text{C}$ típ. $\pm 15 \text{ ppm}/^\circ\text{C}$ máx.
Linealidad	$\pm 0.01 \%$ del fondo de escala
Valor de visualización máximo	100000
Pantalla	LCD de 7 segmentos con retroiluminación (altura del carácter 30 mm)
Actualización de pantalla	10 veces/segundo aprox.
Condiciones de operación	De -10 $^\circ\text{C}$ a 40 $^\circ\text{C}$ , 85 % de humedad relativa o menos (sin condensación)
Entorno de instalación	Solamente para uso en interiores
Altitud	Altitud hasta 2.000 m
Alimentación	<p>&lt;FG-D-CWP (modelo con alimentación por USB)&gt;  Alimentación suministrada desde el adaptador de CA, la batería móvil o el puerto USB tipo A  Longitud del cable USB: 3 m aprox.  (El cable USB también se utiliza para la comunicación).</p> <p>&lt;FG-D-ACWP (modelo con alimentación por AC)&gt;  Red de CA (100 V a 240 V, 50/60 Hz, 0,1 A máx.)  Longitud del cable de CA: 3 m aprox.</p>
Categoría de sobrevoltaje *	II
Grado de contaminación *	2
Dimensiones	Ancho 240 mm x Profundidad 76 mm x Altura 155 mm
Peso (aproximadamente)	1,6 kg (incluyendo el soporte)
Protección contra el polvo y el agua	Conforme con IP67

\* Aplicable únicamente a FG-D-ACWP (modelo de alimentación de CA)



## 1. Introduzione

Questa guida introduttiva descrive le funzioni di base e le operazioni di questo prodotto.

È possibile usare l'indicatore di pesatura FG-D-CWP / FG-D-ACWP su una bilancia a piattaforma impermeabile con prestazioni IP67. Ha specifiche tecniche e funzioni simili a quelle di un indicatore della serie FG-CWP.

I seguenti manuali di istruzioni includono informazioni dettagliate su FG-D-CWP / FG-D-ACWP.

Questi manuali possono essere scaricati dal sito web di A&D (<https://www.aandd.jp>).



Eseguire la scansione di questo codice QR per questo manuale.

[Manuale di istruzioni di FG-D-CWP / FG-D-ACWP]

Manuale di istruzioni utilizzato per il collegamento e l'installazione di FG-D-CWP / FG-D-ACWP su una piattaforma di pesatura (cella di carico).







[Manuale di istruzioni della serie FG-CWP / FG-ACWP]

Manuale di istruzioni per comprendere e utilizzare in modo completo la bilancia digitale a piattaforma impermeabile della serie FG-CWP.

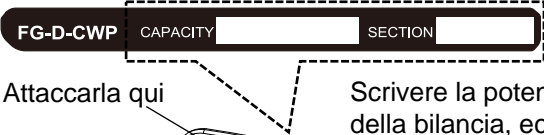

## 2. Articoli inclusi

I seguenti articoli sono forniti in dotazione con il prodotto.

FG-D-CWP (Modello ad alimentazione USB)	FG-D-ACWP (Modello ad alimentazione CA)
<ul style="list-style-type: none"> <li>• FG-D-CWP               <div style="text-align: center;">                 Etichetta del modello (1083039230-1)               </div>  <p>Attaccarla qui</p> <p>Scrivere la potenza della bilancia, ecc.</p> <p>Indicatore</p> <p>Cavo USB (circa 3 m)</p> <ul style="list-style-type: none"> <li>• Adattatore CA                    <p>(Illustrazione)</p> </li> </ul> </li> </ul>	<ul style="list-style-type: none"> <li>• FG-D-ACWP               <div style="text-align: center;">                 Etichetta del modello (1083039230-3)               </div>  <p>Attaccarla qui</p> <p>Scrivere la potenza della bilancia, ecc.</p> <p>Indicatore</p> <p>Cavo CA (circa 3 m)</p> </li> </ul>
<p>※ Accessori comuni per FG-D-CWP / FG-D-ACWP</p> <ul style="list-style-type: none"> <li>• Guida introduttiva                </li> <li>• Guarnizione in gomma (Diametro dei cavi della cella di carico/Utilizzata con <math>\Phi 3,5-7,0</math>)                </li> <li>• Piedini in gomma per il supporto del display (4 pz.)                </li> </ul>	



## 3. Precauzioni



### 3.1. Precauzioni per l'installazione dell'indicatore



#### PERICOLO

- Mettere a terra la bilancia per evitare che l'utente possa essere esposto a scosse elettriche.
- Per evitare le scosse elettriche, non maneggiare il cavo USB / cavo CA con le mani bagnate.
- La spina USB non è resistente all'acqua. Utilizzare una presa USB situata in un luogo in cui la spina non si bagni. (Per FG-D-CWP (modello ad alimentazione USB))
- La spina CA non è resistente all'acqua. Utilizzare una presa elettrica situata in un luogo in cui la spina non si bagni. (Per FG-D-ACWP (modello ad alimentazione CA))
- Non installare la bilancia in presenza di gas infiammabili o corrosivi.
- Non esercitare forza eccessiva sui cavi.
- La bilancia è pesante. Maneggiarla con cura nel sollevarla, perché potrebbe ribaltarsi.
- Utilizzare cavi per celle di carico schermati.

Leggere "Precauzioni per l'installazione della bilancia" nel [Manuale di istruzioni: serie FG-CWP / FG-ACWP] sul sito web di A&D (<https://www.aandd.jp>) per altre precauzioni, utilizzo come bilancia assemblata, conservazione e pulizia.

Leggere "Installazione e precauzioni" nel [Manuale di istruzioni: FG-D-CWP / FG-D-ACWP] sul sito web di A&D (<https://www.aandd.jp>) in relazione al collegamento della cella di carico, l'installazione di indicatori, l'impostazione delle funzioni, la regolazione della sensibilità, ecc.



### 3.2. Collegamento della cella di carico

FG-D-CWP / FG-D-ACWP ha due configurazioni di collegamento: la configurazione a 6 cavi e la configurazione a 4 cavi.

Consigliamo di effettuare il collegamento con una configurazione a 6 cavi per la massima precisione e stabilità.

Il diametro idoneo del cavo della cella di carico va da  $\phi 3,5$  a  $\phi 9,0$  mm.

La lunghezza del cavo della cella di carico deve essere inferiore a 30 m. Per la configurazione a 4 cavi, si consiglia di utilizzare una lunghezza di 5 m o inferiore.

N. del terminale	Funzione	
1	SIG-	Ingresso della cella di carico (-)
2	SIG+	Ingresso della cella di carico (+)
3	EXC-	Tensione di eccitazione della cella di carico (-)
4	SEN-	Ingresso del rilevamento (-)
5	SEN+	Ingresso del rilevamento (+)
6	EXC+	Tensione di eccitazione della cella di carico (+)
7	SHIELD	Schermo

Cella di carico

Cavo

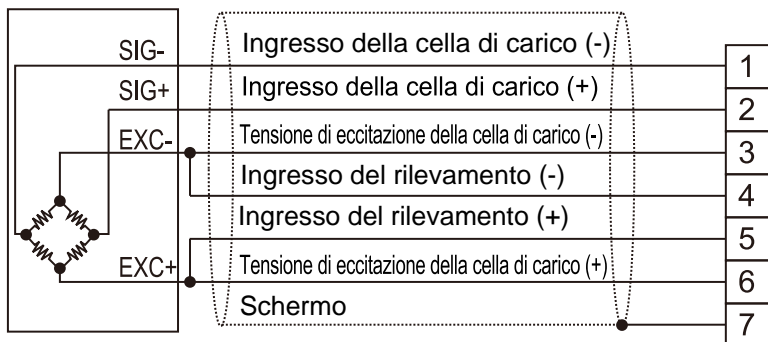

(A) Collegamento alla cella di carico con configurazione a 6 cavi (consigliata)

Cavo

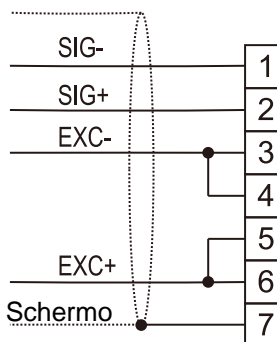

(B) Collegamento alla cella di carico con configurazione a 4 cavi



## 4. Nomi dei componenti

### <FG-D-CWP (Modello ad alimentazione USB)>

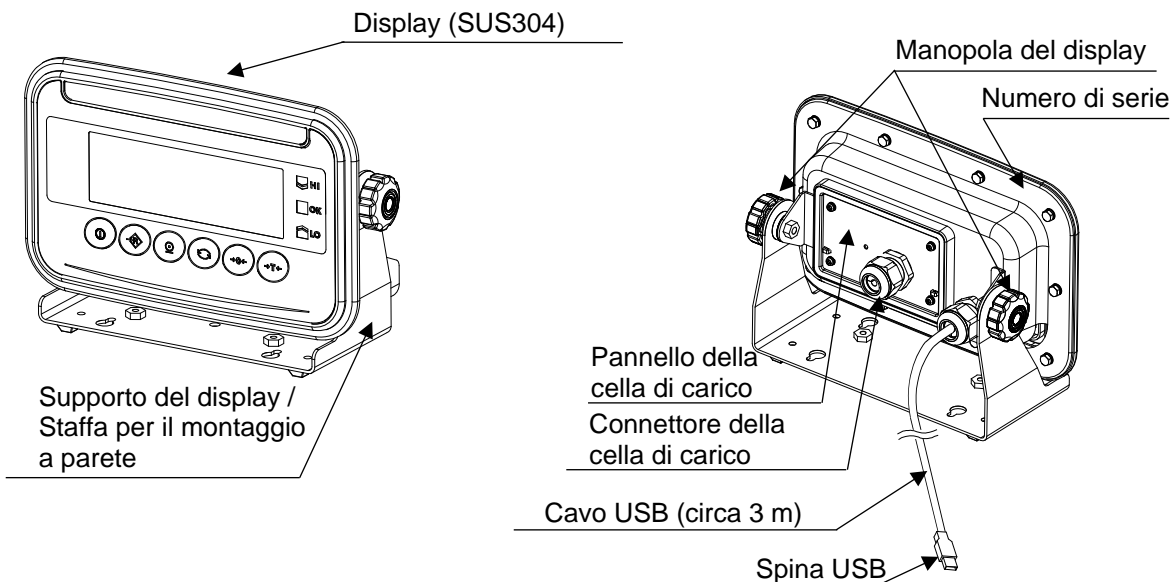

### <FG-D-ACWP (Modelo con alimentación de CA)>

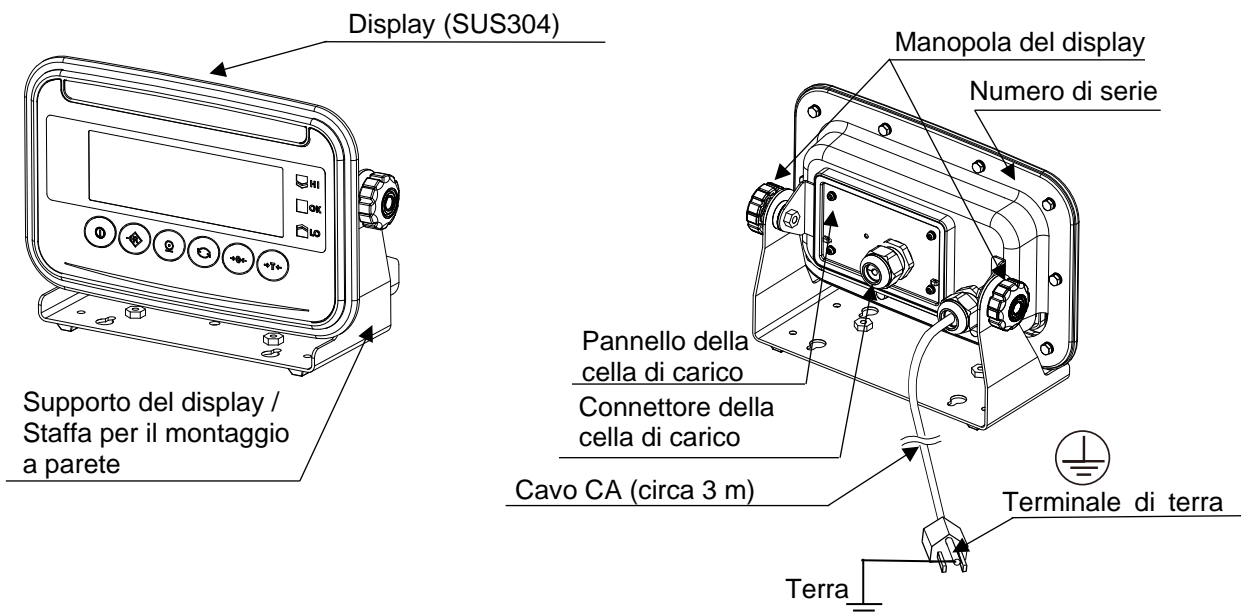



## 4.1. Display e simboli

Display

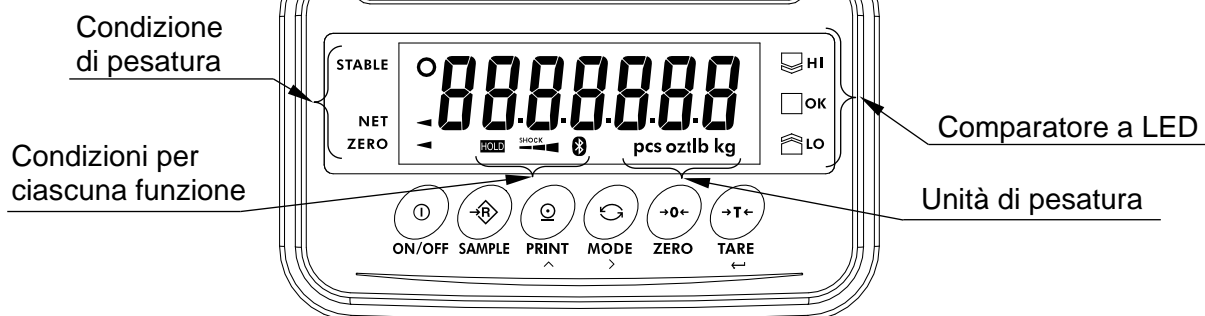

Display/simbolo	Descrizione
STABLE	Si illumina quando il valore di pesatura è stabile, indicando che la bilancia è nella condizione giusta per la lettura dei valori della pesatura.
NET	Si illumina quando si sottrae il peso del contenitore (tara).
ZERO	Si illumina quando la bilancia è sul punto zero (punto di riferimento per la pesatura).
Unità di pesatura	Si illuminano “ kg ”, “ g ”, “ pcs ”, “ oz ”, “ lb ” e “ t ”.
<b>HOLD</b>	Si accende quando il display è bloccato.
<b>SHOCK</b>	Questa funzione rileva l'impatto sulla sezione del sensore di massa e visualizza il livello di impatto.
	Si accende quando si stabilisce la connessione con il ricevitore di comunicazione wireless.
  	Durante l'utilizzo della funzione del comparatore, il valore di pesatura viene confrontato utilizzando i valori soglia preimpostati e l'indicatore visualizza il risultato.
	Corrente alternata.
	Terminale di terra.

- Per informazioni dettagliate sul metodo di funzionamento, sulle varie funzioni, sulla tabella delle funzioni, ecc. fare riferimento al [Manuale di istruzioni: serie FG-CWP / FG-ACWP] sul nostro sito web (<https://www.aandd.jp>).
- Tuttavia, si noti che le funzioni relative a USB e batteria mobile non possono essere utilizzate con FG-D-ACWP (modello ad alimentazione CA).



## 4.2. Tasti funzione

Tasto funzione	Descrizione
 ON/OFF	<b>Tasto ON/OFF</b> Mostra o nasconde il display.
 SAMPLE	<b>Tasto SAMPLE</b> Se si seleziona “pcs” come unità si attiva la modalità di impostazione del peso singolo. Tenendolo premuto (per circa 2 secondi) si attiva la modalità di impostazione della soglia del comparatore.

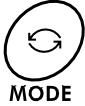
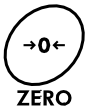
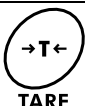
Tasto funzione	Descrizione
 PRINT	<b>Tasto PRINT</b> Emette il valore di pesatura sotto forma di dati. Aumenta il valore della cifra che lampeggia durante l'impostazione.
 MODE	<b>Tasto MODE</b> Commuta l'unità di pesatura. Sposta a destra la cifra che lampeggia durante le impostazioni.
 ZERO	<b>Tasto ZERO</b> A seconda del punto zero pesato al momento dell'accensione del display, se si preme il tasto ZERO quando il valore di peso è stabile entro il $\pm 2\%$ della capacità di pesatura, l'indicatore del punto zero si accende non appena il display diventa zero.
 TARE	<b>Tasto TARE</b> Il peso dell'articolo sul piatto per la pesatura viene sottratto come peso del contenitore (peso della tara).



## 5. Manutenzione

- Fare riferimento a “3. Precauzioni” in relazione all'uso.
- Fare riferimento a “5.3. Tabella dei codici errore” e alla modalità corrispondente per il codice errore visualizzato.
- Fare riferimento al [Manuale di istruzioni della serie FG-CWP / FG-ACWP] sul sito web di A&D (<https://www.aandd.jp>) per la regolazione della sensibilità.
- Controllare periodicamente la precisione della pesatura. Se la bilancia è stata spostata in un luogo diverso o se l'ambiente è cambiato, regolarla.



### 5.1. Riparazione

Non smontare/montare la bilancia se non in presenza di un tecnico autorizzato. In caso contrario, si potrebbero causare scosse elettriche o danni alla bilancia, ecc. In tal caso, la riparazione non sarà coperta da garanzia. Per esigenze di assistenza o riparazione della bilancia, contattare il rivenditore locale di A&D.



### 5.2. Visualizzazione degli errori

In questa situazione	Verificare questo
Non appare nulla sul display. La bilancia non si accende.	<ul style="list-style-type: none"> <li>• La tensione dell'alimentazione principale è quella corretta?</li> <li>• Il cavo di alimentazione principale è collegato correttamente?</li> </ul>
Sulla bilancia non appare lo zero all'inizio.	<ul style="list-style-type: none"> <li>• Controllare intorno al piatto per la pesatura.</li> <li>• C'è qualcosa sul piatto per la pesatura?</li> <li>• Fare riferimento al [Manuale di istruzioni di FG-D-CWP / FG-D-ACWP] sul sito web di A&amp;D (<a href="https://www.aandd.jp">https://www.aandd.jp</a>) ed eseguire la regolazione della sensibilità del punto zero.</li> </ul>
Si visualizza <input type="text" value="E"/> .	• Errore di pesatura che significa “Sovraccarico”.
Si visualizza <input type="text" value="Lo ut"/> .	• Indica che il peso del campione è troppo leggero per poter impostare il peso dell'unità nella modalità di conteggio.
Si visualizza <input type="text" value="-ERR E"/> .	• Errore di regolazione della sensibilità che significa “Troppo leggero”.
Si visualizza <input type="text" value="Lb"/> .	• Appare in caso di caduta dell'alimentazione principale.
Si visualizza <input type="text" value="-----"/> e non avanza.	<ul style="list-style-type: none"> <li>• Il valore pesato è instabile a causa di deriva, vibrazione o altri fattori. Potrebbe esserci una vibrazione o una folata d'aria che interferisce con la misurazione.</li> <li>• Controllare intorno al piatto per la pesatura.</li> <li>• Controllare il collegamento del cavo della cella di carico.</li> <li>• Non si visualizza lo zero quando si accende il display. Rimuovere qualunque oggetto dal piatto.</li> <li>• Fare riferimento al [Manuale di istruzioni di FG-D-CWP / FG-D-ACWP] sul sito web di A&amp;D (<a href="https://www.aandd.jp">https://www.aandd.jp</a>) ed eseguire la regolazione della sensibilità del punto zero.</li> </ul>



In questa situazione	Verificare questo
Display fisso.	<ul style="list-style-type: none"> <li>• È stata utilizzata la “funzione Hold”? Fare riferimento al [Manuale di istruzioni della serie FG-CWP / FG-ACWP] sul sito web di A&amp;D (<a href="https://www.aandd.jp">https://www.aandd.jp</a>) e cambiare la funzione <code>Hold</code>.</li> <li>• Spegnerne la bilancia e riaccenderla.</li> </ul>



### 5.3. Tabella dei codici errore

Se si visualizza uno dei seguenti errori, provare a spegnere e riaccendere il display.

Display	Contenuto
Si visualizza <code>Error 0</code>	Guasto del sensore della temperatura.
Si visualizza <code>Error 3</code>	Guasto della memoria (circuito).
Si visualizza <code>Error 4</code>	Guasto del circuito interno.
Si visualizza <code>Error 5</code>	Guasto del sensore di massa.



## 6. Specifiche tecniche

- Le specifiche tecniche sono soggette a modifiche senza preavviso.

Sensibilità di ingresso	0,1 $\mu\text{V/d}$ min. (d: divisione minima)
Gamma del segnale di ingresso	Da -16 mV a 16 mV
Tensione di eccitazione della cella di carico	5 V $\pm 10\%$
Capacità della cella di carico	Fino a 4 celle di carico da 350 ohm
Zero del coefficiente di temperatura	$\pm 0,02 \mu\text{V}/^\circ\text{C}$ tip. $\pm 0,1 \mu\text{V}/^\circ\text{C}$ max.
Gamma del coefficiente di temperatura	$\pm 3 \text{ ppm}/^\circ\text{C}$ tip. $\pm 15 \text{ ppm}/^\circ\text{C}$ max.
Linearità	$\pm 0,01\%$ del fondo scala
Risoluzione massima del display	100.000
Display	LCD a 7 segmenti con retroilluminazione (altezza del carattere 30 mm)
Aggiornamento del display	Circa 10 volte al secondo
Condizioni operative	Da -10 $^\circ\text{C}$ a 40 $^\circ\text{C}$ , max. 85% di umidità relativa (senza condensa)
Ambiente di installazione	Solo per uso interno
Altitudine	Altitudine fino a 2.000 m
Alimentazione	<p>&lt;FG-D-CWP (modello ad alimentazione USB)&gt; Alimentazione tramite adattatore CA, batteria mobile o porta USB Tipo-A Lunghezza del cavo USB: circa 3 m (Il cavo USB è utilizzato anche per le comunicazioni.)</p> <p>&lt;FG-D-ACWP (modello ad alimentazione CA)&gt; Rete CA (Da 100 V a 240 V, 50/60 Hz, 0,1 A massimo) Lunghezza del cavo CA: circa 3 m</p>
Categoria di sovratensione *	II
Grado di inquinamento *	2
Dimensioni	Larghezza 240 mm x Profondità 76 mm x Altezza 155 mm
Peso (approssimativo)	1,6 kg (supporto incluso)
Protezione da polvere e acqua	Conforme a IP67

\* Applicabile solo a FG-D-ACWP (modello con alimentazione CA).





## 1. 簡介

此快速入門指南描述本產品的基本功能和操作。

FG-D-CWP / FG-D-ACWP 稱重指示器可用於防水等級為 IP67 的防水台秤。其規格和功能與 FG-CWP 系列的指示器類似。

有關 FG-D-CWP / FG-D-ACWP 的詳細資訊，請參閱下列說明手冊。

這些手冊可從 A&D 網站 (<https://www.aandd.jp>) 下載。



掃描此二維碼即可取得本手冊。

[FG-D-CWP / FG-D-ACWP 說明手冊]

本說明手冊係於將 FG-D-CWP / FG-D-ACWP 連接並安裝至稱重台（荷重元）時使用。

[FG-CWP / FG-ACWP 系列說明手冊]

本說明手冊係用於認識和充分運用防水數位台秤 FG-CWP 系列。



## 2. 內容物

產品的包裝內容物如下。

FG-D-CWP (USB 電源機型)	FG-D-ACWP (AC 電源機型)
<ul style="list-style-type: none"> <li>FG-D-CWP               <ul style="list-style-type: none"> <li>型號標籤 (1083039230-1)</li> <li>貼在此處</li> <li>寫下台秤的額定值等</li> <li>指示器</li> <li>USB 纜線 (約 3 m)</li> <li>變壓器 (示意圖)</li> </ul> </li> </ul>	<ul style="list-style-type: none"> <li>FG-D-ACWP               <ul style="list-style-type: none"> <li>型號標籤 (1083039230-3)</li> <li>貼在此處</li> <li>寫下台秤的額定值等</li> <li>指示器</li> <li>AC 纜線 (約 3 m)</li> </ul> </li> </ul>
<p>※ FG-D-CWP / FG-D-ACWP 通用配件</p> <ul style="list-style-type: none"> <li>快速入門指南</li> <li>橡皮墊圈 (荷重元纜線直徑 / 使用 <math>\Phi 3.5</math> 至 7.0 時使用)</li> <li>顯示支架的橡膠支腳 (4 件)</li> </ul>	



## 3. 警告



### 3.1. 指示器安裝注意事項

#### 危險

- 將台秤接地，以免使用者觸電。
- 為了避免觸電，手潮溼時，請勿拿取 USB 纜線／AC 纜線。
- USB 插頭無防水效果。使用插頭不會受潮的 USB 插座。（適用於 FG-D-CWP（USB 電源機型）
- AC 插頭無防水效果。使用插頭不會受潮的電氣插座。（適用於 FG-D-ACWP（AC 電源機型）
- 請勿在有易燃氣體或腐蝕性氣體的地方放置台秤。
- 請勿用力拉扯纜線。
- 台秤很重。請留意抬起台秤時，台秤可能會翻落。
- 請使用屏蔽荷重元纜線。

請前往 A&D 網站 (<https://www.aandd.jp>)，詳閱 [說明手冊：FG-CWP / FG-ACWP 系列] 中的「台秤安裝注意事項」，瞭解其他注意事項，以及台秤組裝、存放和清潔須知。

請前往 A&D 網站 (<https://www.aandd.jp>)，詳閱 [說明手冊：FG-D-CWP / FG-D-ACWP] 中的「安裝和注意事項」，瞭解荷重元連接、指示器安裝、功能設定和靈敏度調整等資訊。



### 3.2. 荷重元連接

FG-D-CWP / FG-D-ACWP 具備兩種連接配置：6 線配置和 4 線配置。

建議使用 6 線配置進行連接，以獲得最佳準確性和穩定性。

荷重元纜線的適用直徑為  $\phi 3.5$  至  $\phi 9.0$  mm。

荷重元纜線的長度應小於 30 m。若為 4 線配置，建議使用 5 m 以下的纜線。

端子編號	功能	
1	SIG-	荷重元輸入 (-)
2	SIG+	荷重元輸入 (+)
3	EXC-	荷重元激發電壓 (-)
4	SEN-	感測輸入 (-)
5	SEN+	感測輸入 (+)
6	EXC+	荷重元激發電壓 (+)
7	屏蔽	屏蔽

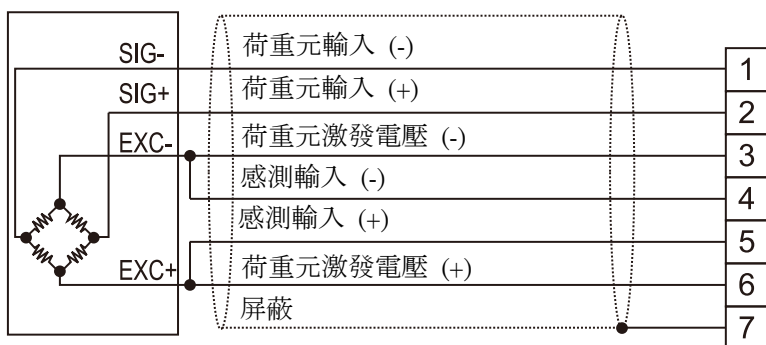

(A) 6 線配置的荷重元連接 (建議)

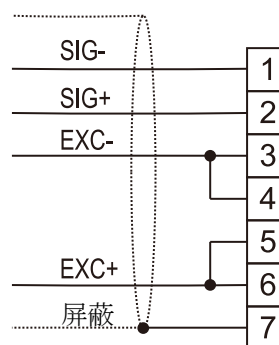

(B) 4 線配置的荷重元連接



## 4. 零件名稱

### <FG-D-CWP (USB 電源機型)>

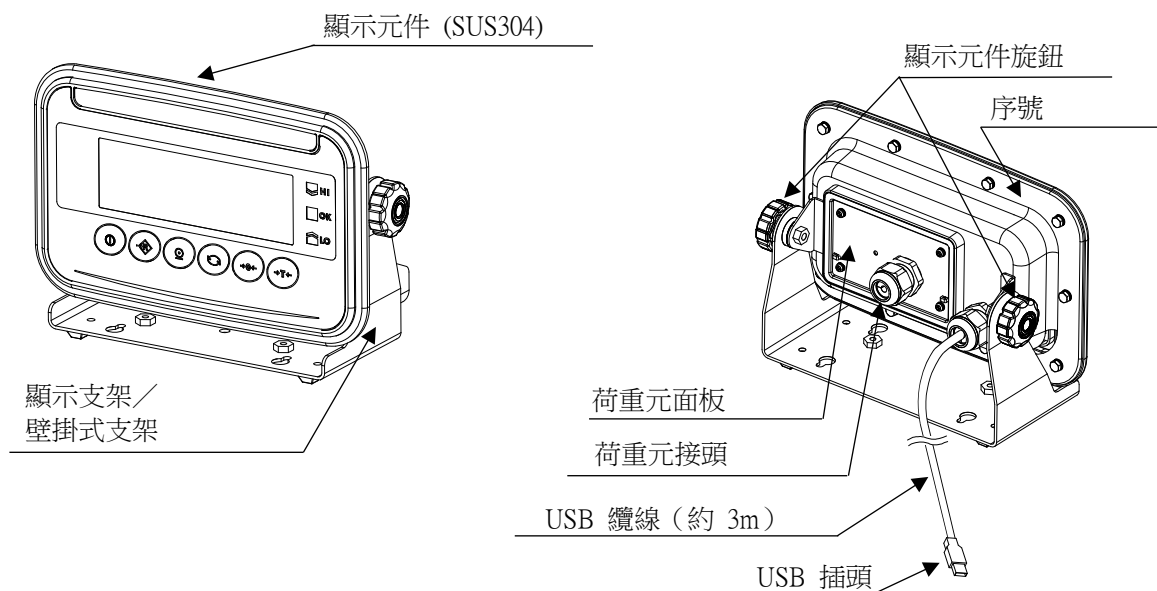

### <FG-D-ACWP (AC 電源機型)>

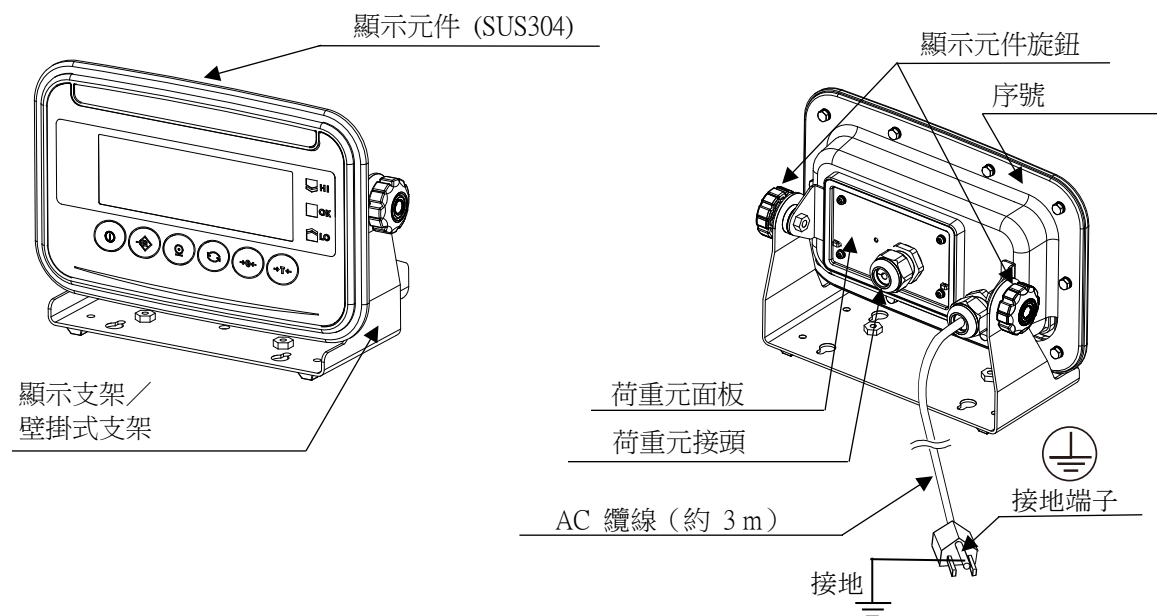



## 4.1. 顯示和符號

顯示元件

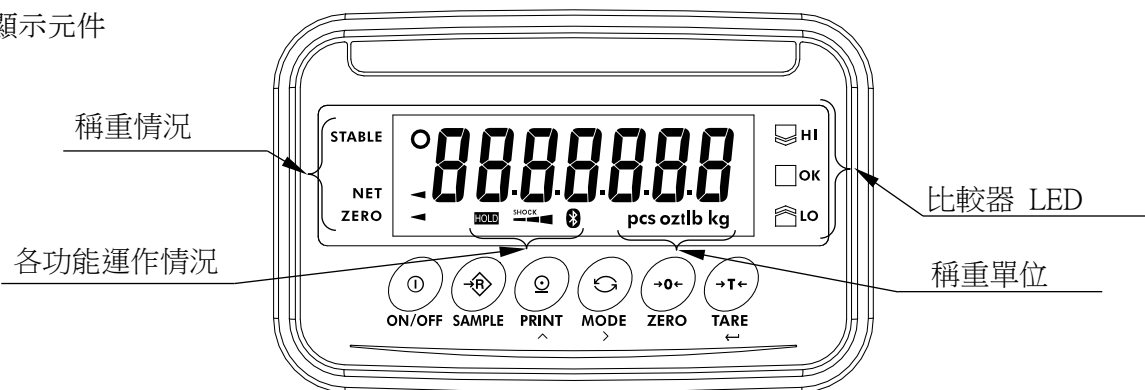



顯示／符號	描述
穩定	稱重值趨於穩定時亮起，代表台秤處於正確狀態，可讀取稱重值。
淨重	減去容器重量（皮重）時亮起。
歸零	台秤在歸零點（稱重參考點）時亮起。
稱重單位	「kg」、「g」、「pcs」、「oz」、「lb」和「t」亮起。
<b>HOLD</b>	保留顯示內容時亮起。
<b>SHOCK</b>	此功能用於偵測質量感測器部分受到的衝擊，並顯示衝擊等級。
	與無線通訊接收器建立連線時亮起。
  	使用比較器功能時，將稱重值與預設閾值進行比較，且指示器顯示結果。
	交流電
	接地端子

- 如需操作方式、各種功能和功能表等詳細說明，請前往我們的網站 (<https://www.aandd.jp>)，參閱 [說明手冊：FG-CWP / FG-ACWP 系列]。
- 然而，請注意，與 USB 和行動電池相關的功能無法搭配 FG-D-ACWP（AC 電源機型）使用。



## 4.2. 操作按鍵

操作按鍵	描述
 ON/OFF	<b>ON/OFF 鍵</b> 顯示或隱藏顯示內容。
 SAMPLE	<b>SAMPLE 鍵</b> 選擇「pcs」作為單位後，啟動個別重量設定模式。 按住按鍵約 2 秒後，啟動比較器閾值設定模式。
 PRINT	<b>PRINT 鍵</b> 將稱重值輸出為資料。 進行設定時，增加閃爍數字的數值。
 MODE	<b>MODE 鍵</b> 切換稱重單位。 進行設定時，切換至閃爍數字的右側。

操作按鍵	描述
	<b>ZERO 鍵</b> 根據開啟顯示器時測得的歸零點，在重量值穩定介於 $\pm 2\%$ 稱重上限之間時按下 ZERO 鍵，一旦顯示數值歸零，歸零點指示燈就會立即亮起。
	<b>TARE 鍵</b> 為減去秤盤上物品的重量，即容器重量（皮重）。



## 5. 維護

- 有關使用方式，請參閱「3. 警告」。
- 有關顯示的錯誤代碼，請參閱「5.3. 錯誤代碼表」和對應模式。
- 有關靈敏度調整，請前往 A&D 網站 (<https://www.aandd.jp>)，參閱 [FG-CWP / FG-ACWP 系列說明手冊]。
- 請定期檢查稱重準確性。如果將台秤移至其他位置或環境有所改變，請調整台秤。



### 5.1. 維修

請勿在沒有授權檢修工程師的情況下，拆解／組裝台秤，否則可能會造成觸電、台秤損壞等問題。如果因此需要維修，將不適用保固。如果您的台秤需要檢修或維修，請聯絡當地 A&D 經銷商。



### 5.2. 錯誤顯示

實際情況	確認項目
未顯示任何內容。 台秤未開啟。	<ul style="list-style-type: none"> <li>主電源電壓是否正確？</li> <li>是否正確連接主電源線？</li> </ul>
台秤一開始未歸零。	<ul style="list-style-type: none"> <li>請檢查秤盤。</li> <li>秤盤上是否有任何物品？</li> <li>請前往 A&amp;D 網站 (<a href="https://www.aandd.jp">https://www.aandd.jp</a>)，參閱 [FG-D-CWP / FG-D-ACWP 說明手冊]，然後執行歸零點靈敏度調整。</li> </ul>
顯示 <input type="text" value="E"/> 。	<ul style="list-style-type: none"> <li>代表「超重」的稱重錯誤。</li> </ul>
顯示 <input type="text" value="Lo ut"/> 。	<ul style="list-style-type: none"> <li>代表樣品重量太輕，無法在計數模式下設定單位重量。</li> </ul>
顯示 <input type="text" value="-[RL E]"/> 。	<ul style="list-style-type: none"> <li>代表「太輕」的靈敏度調整錯誤。</li> </ul>
顯示 <input type="text" value="Lb"/> 。	<ul style="list-style-type: none"> <li>主電源電量低下時顯示。</li> </ul>
顯示 <input type="text" value="-----"/> ， 且無法繼續操作。	<ul style="list-style-type: none"> <li>因偏移、震動等因素，導致稱重值無法趨於穩定。 微風或震動可能會影響測量結果。 請檢查秤盤。</li> <li>請檢查荷重元纜線的連接情形。</li> <li>開啟顯示器時，未顯示零。 請移除秤盤上的物品。</li> <li>請前往 A&amp;D 網站 (<a href="https://www.aandd.jp">https://www.aandd.jp</a>)，參閱 [FG-D-CWP / FG-D-ACWP 說明手冊]，然後執行歸零點靈敏度調整。</li> </ul>
顯示內容固定。	<ul style="list-style-type: none"> <li>是否使用「保留功能」？ 請前往 A&amp;D 網站 (<a href="https://www.aandd.jp">https://www.aandd.jp</a>)，參閱 [FG-CWP / FG-ACWP 系列說明手冊]，然後變更 <input type="text" value="Hold"/> 功能。</li> <li>將台秤關閉再開啟。</li> </ul>



## 5.3. 錯誤代碼表

顯示下列任一錯誤時，請試著將顯示器關閉再開啟。

顯示	內容
顯示 <b>Error 0</b>	溫度感測器故障。
顯示 <b>Error 3</b>	記憶體（迴路）故障。
顯示 <b>Error 4</b>	內部電路故障。
顯示 <b>Error 5</b>	質量感測器故障。



## 6. 規格

□ 規格如有變動，恕不另行通知。

輸入靈敏度	0.1 $\mu\text{V}/\text{d}$ min. (d : 分度值)
輸入訊號範圍	-16 mV 至 16 mV
荷重元激發電壓	5 V $\pm$ 10 %
荷重元磁碟容量	最多 4 x 350 ohm 荷重元
溫度係數 Zero	$\pm 0.02 \mu\text{V}/^\circ\text{C}$ (標準值) $\pm 0.1 \mu\text{V}/^\circ\text{C}$ (最大值)
溫度係數 Span	$\pm 3 \text{ppm}/^\circ\text{C}$ (標準值) $\pm 15 \text{ppm}/^\circ\text{C}$ (最大值)
線性	$\pm 0.01 \%$ 滿刻度
最大顯示解析度	100000
顯示	7 區段背光 LCD (字元高度 30 mm)
顯示更新	約每秒 10 次
操作條件	-10 ° C 至 40 ° C, 85 % R.H. 以下 (非冷凝)
安裝環境	僅限室內使用
高度	海拔高度可達 2,000 米
電源	<FG-D-CWP (USB 電源機型) > 由 AC 變壓器、行動電池或 USB Type-A 連接埠供電 USB 纜線長度：約 3 m (USB 纜線也可作為通訊用途。)
	<FG-D-ACWP (AC 電源機型) > AC 電源 (100V 至 240V, 50/60Hz, 最大 0.1A) AC 纜線長度：約 3 m
過壓類別 *	II
污染程度*	2
尺寸	寬 240 mm $\times$ 深 76 mm $\times$ 高 155 mm
重量 (約略值)	1.6 kg (含支架)
防水防塵性能	符合 IP67

\* 僅適用於 FG-D-ACWP (交流電源型號)

THIS PAGE INTENTIONALLY LEFT BLANK.





### **A&D Company, Limited**

3-23-14 Higashi-Ikebukuro, Toshima-ku, Tokyo 170-0013, JAPAN  
Telephone: [81] (3) 5391-6132 Fax: [81] (3) 5391-1566

### **A&D ENGINEERING, INC.**

47747 Warm Springs Blvd, Fremont, California 94539, U.S.A.  
Tel: [1] (800) 726-3364 Weighing Support:[1] (888) 726-5931 Inspection Support:[1] (855) 332-8815

### **A&D INSTRUMENTS LIMITED**

Unit 24/26 Blacklands Way, Abingdon Business Park, Abingdon, Oxfordshire OX14 1DY United Kingdom  
Telephone: [44] (1235) 550420 Fax: [44] (1235) 550485

### **A&D AUSTRALASIA PTY LTD**

32 Dew Street, Thebarton, South Australia 5031, AUSTRALIA  
Telephone: [61] (8) 8301-8100 Fax: [61] (8) 8352-7409

### **A&D KOREA Limited**

한국에이.엔.디(주)  
서울특별시 영등포구 국제금융로6길33 (여의도동) 맨하탄빌딩 817 우편 번호 07331  
( 817, Manhattan Bldg., 33. Gukjegeumyung-ro 6-gil, Yeongdeungpo-gu, Seoul, 07331 Korea )  
전화: [82] (2) 780-4101 팩스: [82] (2) 782-4264

### **ООО A&D RUS**

### **ООО "ЭЙ энд ДИ РУС"**

Почтовый адрес:121357, Российская Федерация, г.Москва, ул. Вереysкая, дом 17  
Юридический адрес: 117545, Российская Федерация, г. Москва, ул. Дорожная, д.3, корп.6, комн. 86  
( 121357, Russian Federation, Moscow, Vereyskaya Street 17 )  
тел.: [7] (495) 937-33-44 факс: [7] (495) 937-55-66

### **A&D Instruments India Private Limited**

### **ऐ&डी इन्स्ट्रुमेन्ट्स इण्डिया प्रा० लिमिटेड**

D-48, उद्योग विहार , फेस -5, गुडगांव - 122016, हरियाणा , भारत  
( D-48, Udyog Vihar, Phase-V, Gurgaon - 122016, Haryana, India )  
फोन : [91] (124) 4715555 फैक्स : [91] (124) 4715599

### **A&D SCIENTECH TAIWAN LIMITED. A&D台灣分公司 艾安得股份有限公司**

台灣台北市中山區南京東路2段206號11樓之2  
( 11F-2, No.206, Sec.2, Nanjing E.Rd., Zhongshan Dist., Taipei City 10489, Taiwan, R.O.C. )  
Tel : [886](02) 2322-4722 Fax : [886](02) 2392-1794

### **A&D INSTRUMENTS (THAILAND) LIMITED**

### **บริษัท เอ แอนด์ ดี อินสตรูमेंท์ (ไทยแลนด์) จำกัด**

168/16 หมู่ที่ 1 ตำบลรังสิต อำเภอธัญบุรี จังหวัดปทุมธานี 12110 ประเทศไทย  
( 168/16 Moo 1, Rangsit, Thanyaburi, Pathumthani 12110 Thailand )  
Tel : [66] 20038911